

# **SHERA™**

build better, live better

## **SHERA Product Catalog**



Ceiling Application

Wall Application

Floor Application

[www.SHERA.com](http://www.SHERA.com)

Decorative Application

Roof Application

# Index

01	Ceiling Application	06
02	Wall Application	14
03	Floor Application	22
04	Decorative Application	32
05	Roof Application	38
	Technical Data	46
	Product List	54



**SHERA™**

build better, live better



05

01

02

# Green Innovation

**SHERA** responds to our customers and their family with innovative development of wood substituted products for flooring, walling and ceiling applications that serves all needs in your home and other buildings



# SHERA



SHERA has been Thailand's first leader of complete synthetic wood since 1997 by application of globally accepted cutting-edge manufacturing technology including

### Hatschek Technology

SHERA wood is produced with Hatschek technology to ensure its strength by elaborately weaving fiber cement in each layer and applying complete chemical interaction process to create outstanding SHERA products which are stronger and more flexible than materials made with any other processes. Then, the products are transferred to molding process.

### Autoclave Technology

Under the internationally accepted Autoclave technology, SHERA wood become one of the most perfect materials. Our products are baked in the pressure and heat controlled room to ensure that each piece of wood is of the same quality standard.

All SHERA's products are, high quality international standards.

Properties	Fibre Cement	Real wood	WPC	Ply	Gypsum
Termite Free	✓✓	X	✓✓	X	✓
No Rotting	✓✓	X	X	X	✓
Heat and Fire Resistant	✓✓	X	X	X	X
Moisture Resistant	✓✓	X	✓✓	X	X
No Cemical	✓✓	✓✓	X	X	X
Low Shrinkage	✓✓	X	X	X	✓✓
Looks like real wood	✓✓	✓✓	✓✓	-	-
Weather Resistant	✓✓	X	✓	✓	✓
Easy to paint	✓	✓	✓	✓	✓✓
Low Maintainance	✓✓	✓	✓	✓	✓✓
Environmental Friendly	✓✓	✓✓	X	✓✓	✓
Sound Reduction	✓✓	-	-	✓	✓✓

# *Ceiling Application*



The fundamental of ceiling application is to create a sense of beauty while providing great functionality to a house such as preventing heat transfer from the rooftop, facilitating ventilation under the roof, as well as giving the house a clean, neat and pretty finish. Since ceiling will have to go through seasonal changes that usually come with water, humidity and termite problems especially in hidden, hard-to-clean spots, it's also important to keep strength and durability in mind so that owners can enjoy the comfort of their own houses without having to worry about maintenance.

- *SHERA Strip*
- SHERA Ceiling Skirt*
- SHERA Ceiling Board*
- SHERA Vent Ceiling*
- SHERA Deco Ceiling*





## SHERA Strip

Building your ceiling with **SHERA Strip** is a great way to improve ventilation effectively, leaving your indoor space cool and comfortable. It also gives you the flexibility to achieve the ultimate beauty for any indoor and outdoor ceiling designs. **SHERA Strip** is strong and durable in any weather conditions and comes with different color choices from natural wood grains all the way to painted wood options and Shine Light series.

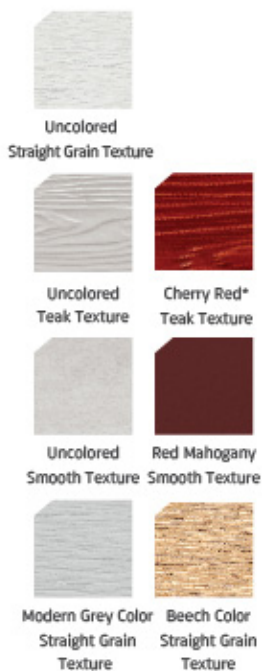

### Product Information

Profile	Texture	Color	Size (cm.) (Thickness*Width*Length)	Weight (kg./pc.)	Quantity (pc./sq.m.)
Square-Cut Edge	Straight Grain	Uncolored	0.8 x 5.0 x 300	1.80	6.67
		Uncolored	0.8 x 5.0 x 300	1.80	6.67
Square-Cut Edge	Teak	Uncolored	0.8 x 7.5 x 300	2.70	4.45
		Cherry Red*	0.8 x 7.5 x 300	2.70	4.45
		Uncolored	0.8 x 7.5 x 300	2.70	4.45
Square-Cut Edge	Smooth	Uncolored	0.8 x 10 x 300	3.60	3.34
		Red Mahogany	0.8 x 7.5 x 300	2.70	4.45
V-Cut Edge	Straight Grain	Uncolored	0.8 x 7.5 x 300	2.65	4.45
		Uncolored	0.8 x 10 x 300	3.55	3.34
		Beech	0.8 x 7.5 x 300	2.65	4.45
		Modern Grey	0.8 x 7.5 x 300	2.65	4.45

Remark: \*made to order item



# SHERA Shine Light Strip

SHERA Shine Light Strip is designed with an ultra thick coating innovation which enhances the beauty and lasting of color. With its distinctive wooden textures and colors, SHERA Shine Light Strip underlines natural look and more for your home. Worry less about maintenance from now on with a self-cleaning technology which reduces dust adhesion to the surface and increases your peace of mind.

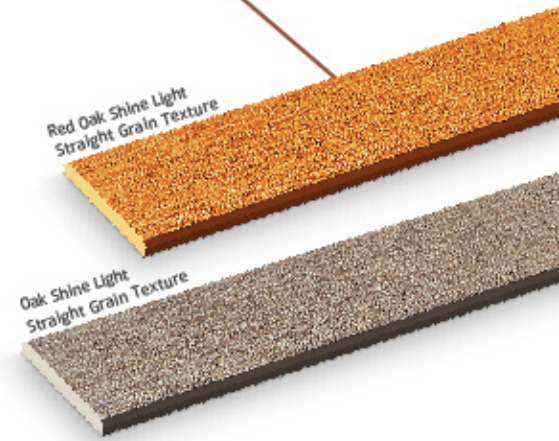

## Product Information

*Shine Light  
Timeless Beauty*



Oak Shine Light Straight Grain Texture    Red Oak Shine Light Straight Grain Texture

Profile	Texture	Color	Size (cm.) (Thickness*Width*Length)	Weight (kg./pc.)	Quantity (pc./sq.m.)
V-Cut Edge	Straight Grain	Oak Shine Light Red Oak Shine Light	0.8 x 7.5 x 300	2.65	4.45

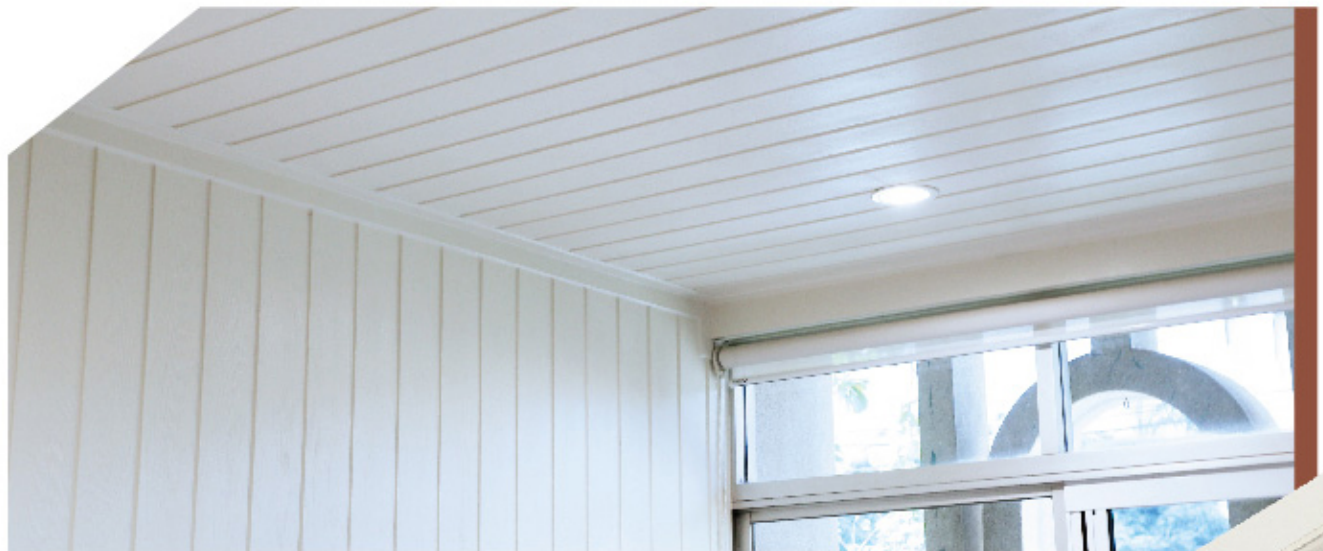

# SHERA Ceiling Skirt

Create a completely neat finish where the wall and ceiling meet with SHERA Ceiling Skirt. Add some beauty to baseboard and cornice with our skirting profile which is not only beautiful but also durable and easy to clean. No more stains or termites to worry about. Ensure the perfect finish for your ceiling installation with SHERA ceiling skirt.



## Product Information



Uncolored Smooth Texture

Profile	Texture	Color	Size (cm.) (Thickness*Width*Length)	Weight (kg./pc.)
Classic	Smooth	Uncolored	0.8 x 5.0 x 300	1.80
			0.8 x 7.5 x 300	2.70
Modern	Smooth	Uncolored	0.8 x 5.0 x 300	1.80
			0.8 x 7.5 x 300	2.70



Create a loft-style wall with SHERA Ceiling Skirt instead of traditional brick.



## SHERA Ceiling Board

SHERA *Ceiling Board* is durable and suitable for external soffit and internal ceiling. It's also an ideal application for wet areas such as bathroom, kitchen, garage and eaves, etc. SHERA Ceiling Board is tough and strong, not brittle, not crack easily and doesn't contain any asbestos content. Other properties include water, moisture resistance and bendability as needed, making it a perfect ceiling material for interior and exterior.

### Product Information

Profile	Color	Size (cm.) (Thickness*Width*Length)	Weight (kg./pc.)	Quantity (pc./sq.m.)	Application area
Square-Cut Edge	Uncolored	0.35 x 122 x 122	8.14	0.67	Interior Ceiling
		0.35 x 122 x 244	16.28	0.34	
		0.40 x 122 x 122	9.30	0.67	Interior and exterior ceiling
		0.40 x 122 x 244	18.61	0.34	
		0.45 x 122 x 244	20.90	0.34	
		0.60 x 122 x 244	27.91	0.34	

Available in metric size.

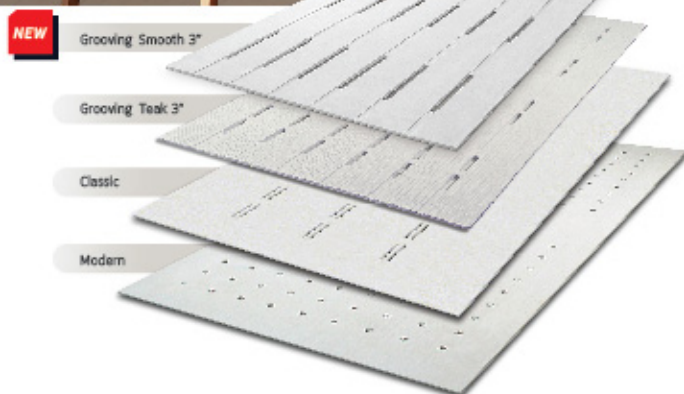
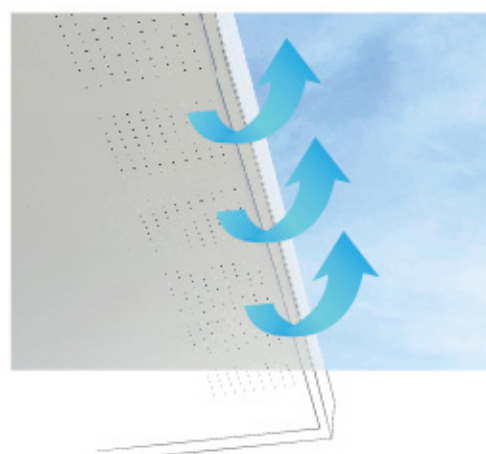

## SHERA Vent Ceiling

Sunlight in Thailand can increase temperature and humidity in your home and make it unpleasant to live in. That's why it's important to choose the right material that comes with great benefits to make your home pleasurable again. **SHERA Vent Ceiling** can tolerate sunlight and rain. It is also rot-resistant and suitable for exterior soffit. By facilitating the wind flow and ventilation under the roof, **SHERA vent ceiling** can make your home cooler and more comfortable even without air conditioning and therefore helps reduce your electricity use.

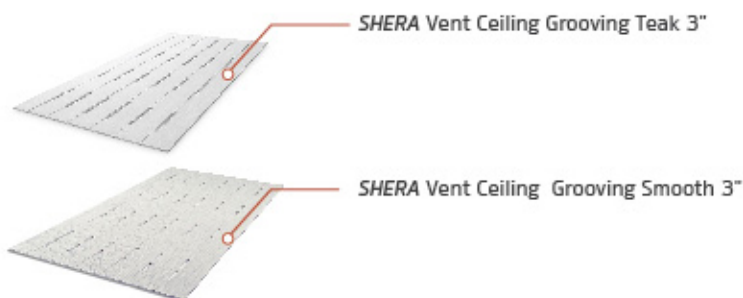

### Product Information

Profile	Color	Size (cm.) (Thickness*Width*Length)	Weight (kg./pc.)	Quantity (pc./sq.m.)	Application area
Modern	Uncolored	0.32 x 60 x 120	3.52	1.39	Exterior soffit
		0.32 x 61 x 122	3.72	1.34	
		0.40 x 60 x 120	4.41	1.39	
Classic	Uncolored	0.32 x 60 x 120	3.52	1.39	
		0.40 x 60 x 120	4.41	1.39	
Grooving Teak 3"		0.40 x 60 x 120	4.01	1.39	
Grooving Smooth 3"		0.40 x 60 x 120	4.25	1.39	



## SHERA Deco Ceiling

Make your decoration complete and bring nature elements into your spaces as your heart desires with *SHERA Deco Ceiling*. This decorative solution has many outstanding properties including durability in any weather conditions and resistance to water, humidity, fire, impact as well as termites. It's also sound proofing when cutting, hammering or drilling, making installation become easy. So when it comes to expressing your personal style through designs, *SHERA Deco Ceiling* is the answer.

### Product Information



Rocco Texture



Blossom Texture



Cassia Texture

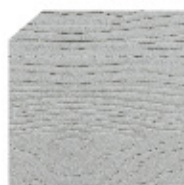

Teak Texture



Cassiano Texture

Texture	Color	Size (cm.) (Thickness*Width*Length)	Weight (kg./pc.)	Quantity (pc./sq.m.)	Application area
Rocco/Blossom	Uncolored	0.35 x 120 x 240	15.77	0.35	Interior and exterior decorative ceiling
		0.35 x 122 x 244	16.28	0.34	
Cassia		0.35 x 120 x 240	15.77	0.35	
Teak		0.40 x 122 x 244	18.61	0.34	
Cassiano		0.45 x 122 x 244	21.39	0.34	



Blossom Texture



Rocco Texture



Teak Texture



Cassiano Texture

# *Wall Application*



# SHERA™

build better, live better

Wall is a key element of home building in terms of boundary forming and indoor space allocating. From exterior wall to room partition, wall helps to provide protection from outside and divide the space inside your home proportionally based on lifestyles of all family members. Therefore, this wall should be strong and durable enough to provide a long-lasting service of protecting your privacy and upholding the beauty of your common space.

SHERA Plank

SHERA Plank Shine Light **NEW**

SHERA Splendid Plank

SHERA Splendid Plank De'line **NEW**

SHERA Strip

SHERA Wall Board

SHERA Deco' Board













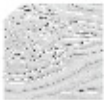



# SHERA Plank

The first product that comes into everyone's mind when mentioning **SHERA** is **SHERA Plank**, an alternative to wooden decoration that gives you the same warmth you would get from real wood texture. With a full range of features from low shrinkage and no wrapping to termite-resistance, you can create a cozy atmosphere inside your home with this natural glow.

**SHERA** plank is suitable for interior and exterior wall decorations. It also comes in several sizes and colors to suit your style and preferences: uncolored, painted and Shine Light series.



## Product Information

Profile	Texture	Color	Size (cm.) (Thickness*Width*Length)	Weight (kg./pc.)	Quantity (pc./sq.m.)
 Uncolored Antique Wood	Antique Wood	Uncolored	0.8 x 15 x 300	5.40	2.67
			0.8 x 20 x 300	7.20	2.00
 Uncolored Straight Grain	Straight Grain	Uncolored	0.8 x 15 x 300	5.40	2.67
			Cassia	0.8 x 15 x 400	7.20
	Cassia			0.8 x 20 x 300	7.20
			0.8 x 20 x 400	9.60	1.50
<b>Teak Texture</b>  Uncolored  Modern Grey  Light Yellow  Light Blue Square-Cut Edge  Golden Sand Teak  Golden Teak  Honey Teak Brown  Walnut  Merbau Brown  Afromosia Brown  Red Mahogany  Cherry Red	Teak	Uncolored	0.8 x 15 x 300    5.40    2.67 0.8 x 15 x 400    7.20    2.00 0.8 x 20 x 300    7.20    2.00 0.8 x 20 x 400    9.60    1.50		
		Modern Grey			
		Light Yellow			
		Light blue			
		Walnut			
		Merbau Brown			
		Afromosia Brown			
		Golden Sand Teak			
		Golden Teak			
		Afromosia Brown			
		Red Mahogany			
		Cherry Red			



**NEW**

# SHERA Shine Light Plank

Add a shiny, glamorous look to your wall with our ultra-thick coating innovation. **SHERA Shine Light Plank** will give a high-glossy finish and distinct wooden appearance to the wall surface. And with an innovative self-cleaning feature, **SHERA Shine Light Plank** helps reduce allergy-triggering dust in your home. It is also resistant to all kinds of weather and able to maintain its wood-like charm. **SHERA Shine Light Plank** is designed to ensure the long-lasting beauty for your places.

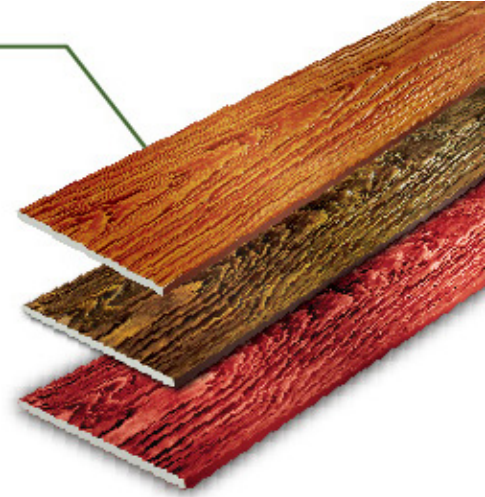

*Shine Light  
Timeless Beauty*

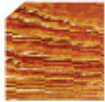

Golden Teak  
Shine Light

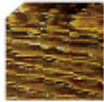

Brown Teak  
Shine Light

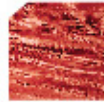

Rose wood  
Shine Light

## Product Information

Profile	Texture	Color	Size (cm.) (Thickness*Width*Length)	Weight (kg./pc.)	Quantity (pc./sq.m.)
Square-Cut Edge	Teak	Golden Teak Shine Light	0.8 x 15 x 300	5.40	2.67
		Brown Teak Shine Light	0.8 x 15 x 400	7.20	2.00
		Rose wood Shine Light	0.8 x 20 x 300	7.20	2.00
			0.8 x 20 x 400	9.60	1.50



# SHERA Splendid Plank

Incorporate naturalness into your modern wall designs with patterns and textures of real wood.

**SHERA Splendid Plank** comes with two installation options: vertical and horizontal, and a unique feature of hidden screw marks on each plank. You can achieve the perfect screwless wall with both overlapping and grooving styles. Enjoy your safe, smooth, and durable walls in every season because **SHERA Splendid Plank** ensures beauty and strength that withstand the test of time

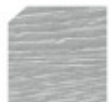

Uncolored  
Cassia Texture



Uncolored  
Smooth Texture



Beech  
Straight Grain Texture

## Product Information

Profile	Color	Size (cm.) (Thickness*Width*Length)	Weight (kg./pc.)			Quantity (pc./sq.m.)	Section image
			Cassia	Smooth	Straight Grain		
Orchid Tree	Uncolored	1.0 x 15 x 300	6.73	6.73	-	2.67	
		1.0 x 20 x 300	-	8.97	-	1.67	
Croton	Uncolored	1.0 x 15 x 300	5.65	5.65	-	2.57	
Jacaranda		1.0 x 15 x 300	5.74	-	-	2.55	
Modern Stagger	Uncolored	1.0 x 10 x 300	-	3.63	-	4.17	
		1.0 x 15 x 300	-	5.88	-	2.57	
		1.0 x 20 x 300	-	8.13	-	1.86	
Yellow Flame	Uncolored Beech	1.0 x 15 x 300	5.65	5.65	5.65	2.57	



*Do not hammer nails directly when applying splendid plank as ceiling, kindly use screws to ensure the long service life.*



Site Reference



## SHERA Splendid Plank De'line

SHERA Splendid Plank De'line is designed for any striking modern architectural style you have in mind. It comes with 5 different grooved lines that can be applied to your indoor and outdoor in many styles that suit you.

### Product Information

Profile	Texture	Color	Size (cm.) (Thickness*Width*Length)	Weight (kg./pc.)	Quantity (pc./sq.m.)	Section image
Deline DL00	Smooth	Uncolored	1.0 x 22 x 300	8.93	1.64	
Deline DL01			1.0 x 22 x 300	8.77	1.64	
Deline DL02			1.0 x 22 x 300	8.60	1.64	
Deline DL05			1.0 x 22 x 300	8.12	1.64	
Deline DX12			1.0 x 22 x 300	8.44	1.64	

## SHERA Strip

### Product Information

Profile	Texture	Color	Size (cm.) (Thickness*Width*Length)	Weight (kg./pc.)	Quantity (pc./sq.m.)
Square-Cut Edge	Straight Grain	Uncolored	0.8 x 5.0 x 300	1.80	6.67
		Uncolored	0.8 x 5.0 x 300	1.80	6.67
Square-Cut Edge	Teak	Uncolored	0.8 x 7.5 x 300	2.70	4.45
		Cherry Red*	0.8 x 7.5 x 300	2.70	4.45
		Uncolored	0.8 x 7.5 x 300	2.70	4.45
Square-Cut Edge	Smooth	Uncolored	0.8 x 10 x 300	3.60	3.34
V-Cut Edge		Red Mahogany	0.8 x 7.5 x 300	2.70	4.45
V-Cut Edge	Straight Grain	Uncolored	0.8 x 7.5 x 300	2.65	4.45
		Uncolored	0.8 x 10 x 300	3.55	3.34
		Beech	0.8 x 7.5 x 300	2.65	4.45
V-Cut Edge	Straight Grain	Modern Grey	0.8 x 7.5 x 300	2.65	4.45
		Oak Shine Light	0.8 x 7.5 x 300	2.65	4.45
		Red Oak Shine Light	0.8 x 7.5 x 300	2.65	4.45

Remark: \*made to order color



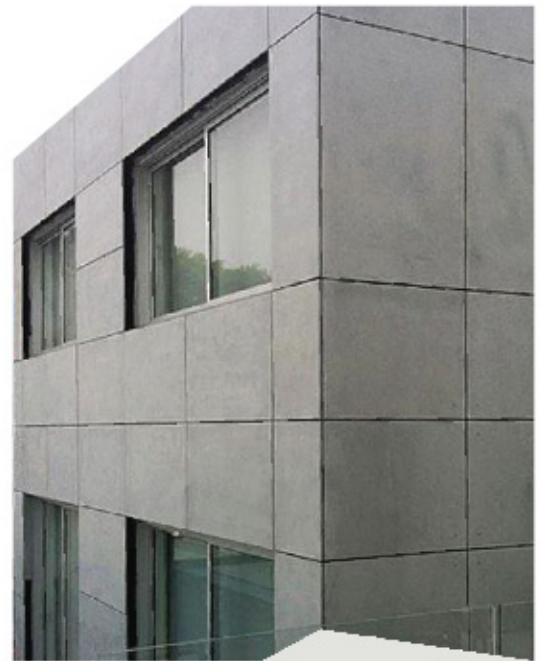

## SHERA Wall Board

SHERA Wall Board is an ideal solution to walling, especially designed for indoor and outdoor wall applications. This series comes with a square-cut edge profile for exposed - joint wall and a recessed edge profile for smooth seamless wall. Installation is easy with cutting and drilling. Other great properties include durability, resistance to water-humidity-fire-impact and soundproof, therefore it is a perfect choice for walling in residential, hotel, resort, and industrial buildings. SHERA Wall Board will bring a good quality of life to homeowners everywhere.



### Smooth seamless jointing

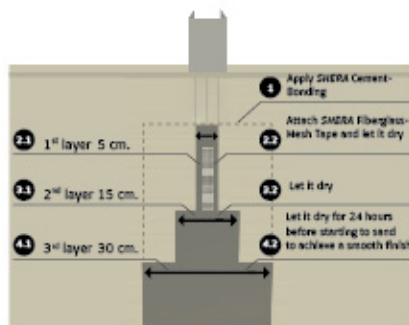

### Product Information



Profile	Size (cm.) (Thickness*Width*Length)	Weight (kg./pc.)	Quantity (pc./sq.m.)	Application area
Square-Cut Edge	0.6x122x244	27.91	0.34	Interior and exterior wall
	0.8x122x244	37.26		
	1.0x122x244	46.58		
Recessed Edge	1.2x122x244	54.08	0.34	Smooth interior wall *made to order item
	0.6x122x244	27.66		
	0.8x122x244	36.99		

Available in metric size.

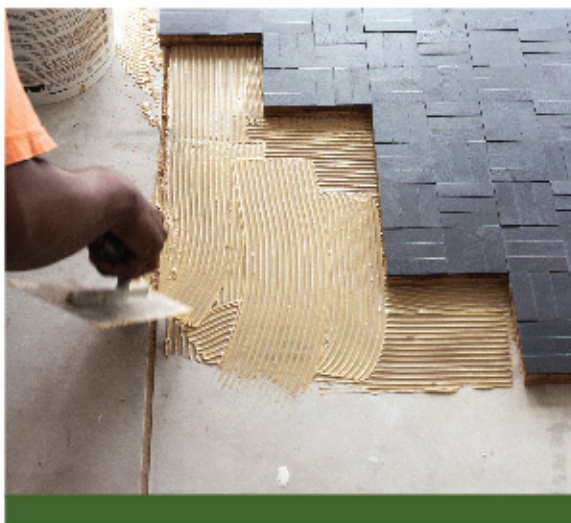

### Underlay SHERA Board

#### Underlay Board for Floor

SHERA Board with 8, 10 and 12 mm. thickness helps you prepare the flooring surface quicker than other conventional methods, a better way to achieve a completely level floor with less installation time. It also prevents further moisture issues and provides a quality substrate for various finishing such as ceramic tiles, engineered wood, laminate, parquet and rubber tiles. SHERA Board will help adjust level of flooring surface easier, smoother, and more durable.

#### Underlay Board for Roof

SHERA Board with 6, 8, 10 and 12 mm. thickness is an essential protective layer that helps prevent water leaking from the roof. It's suitable to apply as an underlay to roofs with 25-40 degree pitch. And for the maximum result, it's recommended that SHERA board is installed on rafters horizontally prior to installing purlins and roofs.



## SHERA Deco Board

Allow your space to show off its strikingly beautiful texture and architectural dimension with **SHERA Deco Board**. These beautiful patterns are crafted to go with several designs, making your home decor project more unique and outstanding than ever. **SHERA Deco Board** comes with a full range of properties including resistance to weather, water, moisture and fire which are the key components in terms of functionality. It's also soundproof and impact-resistant, which is ideal for both internal and external decorative applications. Installation is easy with screwing, cutting and drilling. In a word, **SHERA Deco Board** gives you a very convenient way to make your room look perfect.



### Product Information

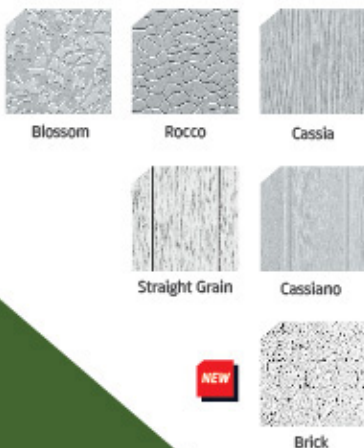

Texture	Size (cm.) (Thickness*Width*Length)	Weight (kg./pc.)	Quantity (pc./sq.m.)	Application area
Blossom/Rocco/Cassia	0.6 x 120 x 240	27.04	0.35	Decorative interior and exterior walls
	0.6 x 122 x 244	27.91	0.34	
Cassiano	0.6 x 120 x 240	27.04	0.35	
	0.6 x 122 x 244	27.91	0.34	
	0.8 x 120 x 240	36.05	0.35	
Straight Grain 3"	0.6 x 120 x 240	26.42	0.35	
	0.6 x 122 x 244	27.91	0.34	
	0.6 x 120 x 240	27.75	0.35	
Brick	0.6 x 122 x 244	27.91	0.34	
	0.8 x 120 x 240	37.05	0.35	



\*The real product will be in cement color out of factory.  
The product in the picture has been painted for advertising only.

# *Floor Application*



Floor is the main part of every home and building needs to be planned since the beginning. Besides supporting the weight of all structures, nice flooring can make a striking statement in your home and building comfort feeling under your feet. That's why it's important to choose the right material by looking at qualifications, room's functions, budgets and designs that match your need.

**SHERA** Floor Plank is the answer to everything you need for flooring installation due to its high strength. In addition to that, it does not bend, swell, twist, nor squeak. It's also termite-resistant and easy to install. Combining all these properties together, **SHERA** Floor Plank helps ensure the durability and beauty of the floor that's going to last the full lifespan of your home.

- **SHERA** Floor Plank Color Through
- SHERA** Floor Plank Color Through Anti Slip **NEW**
- SHERA** Floor Plank Color Through Double Series **NEW**
- SHERA** Floor Plank Clip-Lock Series **NEW**
- SHERA** Floor Plank with Grooves
- SHERA** Stair
- SHERA** Stair Anti Slip **NEW**
- SHERA** Floor Board





Colors of products shown in pictures may differ from the actual products due to printing system.

## SHERA Floor Plank Color Through

Growing more innovative, **SHERA** Floor Plank Color Through has pigment particles infused into it. Making the color stay true and scratch resistant for a long period of time. Home lovers are going to love this.

### Special Properties

- Painted and ready to install
- Color texture remains beautiful even with scratches
- Beautiful as natural wood
- Easy to install on 30- 40 cm. joist spacing frames



*New SHERA Floor Plank Color Through will have enhanced beauty, endurance and resistant to scratches when combining with SHERA TOP GUARD (TG-000)*



COATED  
SHERAGRIP®



### SHERA Floor Plank Color Through Anti Slip

- Beautiful as natural wood
- Anti-slip with micro polymer
- Safety certified by European standards

### Product Information

Profile	Series	Texture	Color	Size (cm.) (Thickness*Width*Length)	Weight (kg./pc.)	Quantity (pc./sq.m.)
V-Cut Edge	Color Through	Straight Grain	Wenge Brown	2.5 x 15 x 300	17.75	2.22
			Tropical Oak			
			Golden Sand Teak			
	Color Through Anti Slip	Straight Grain	Cassia	2.5 x 20 x 300	23.67	1.67
			Chestnut Brown			
			Tropical Oak			
-	-	Straight Grain	Jasmine White Primer*	2.5 x 15 x 300	17.75	2.22
			Cassia			
-	-	Straight Grain	Jasmine White Primer*	2.5 x 20 x 300	23.67	1.67
			Cassia			

\*Primer on uncolored product



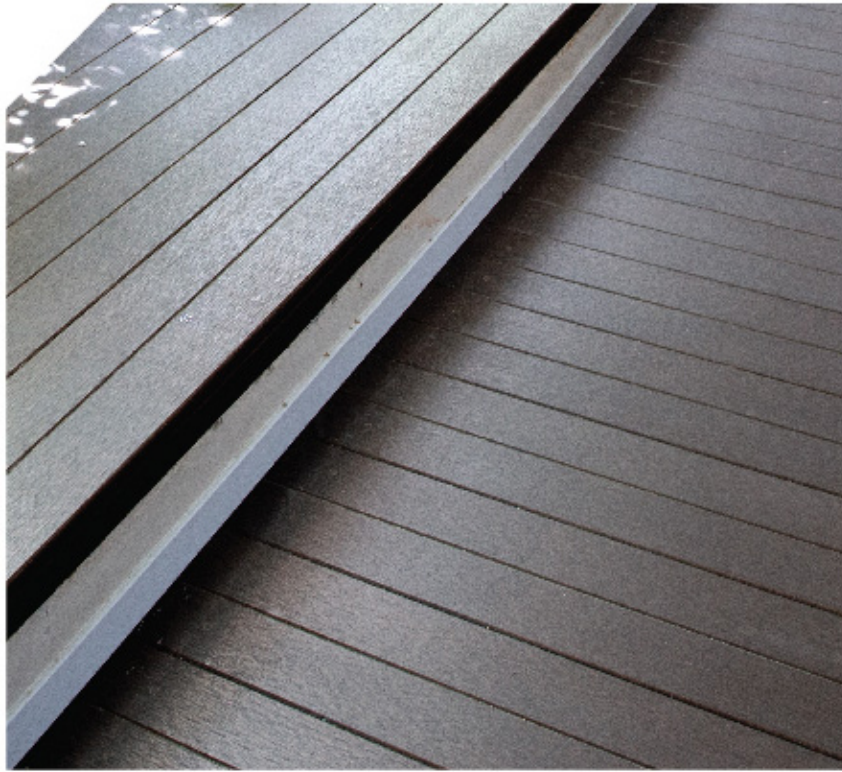

## **NEW** SHERA Floor Plank Color Through Double Series

- ✓ Less maintenance
- ✓ Weather Resistance
- ✓ Feel Naturally

### Product Information

	Profile	Color	Texture	Size (cm.) (Thickness*Width*Length)	Weight (kg./pc.)	Quantity (pc./sq.m.)
		Wenge Brown	Straight Grain	2.5 x 20 x 300	23.61	1.67
		Tropical Oak				
		Jasmine White Primer*				

\*Primer on uncolored product



### SHERA Plug

Perfect your floor without having to touch up screw heads with this new approach.



Wenge Brown



Tropical Oak



Golden Sand Teak



Cheznut Brown

#### Properties of SHERA Plug



UV resistant coated to prevent color fading



Ultra strong texture



Wood grain texture on SHERA Plug

#### Floor installation with SHERA Plug



1. Drill a hole



2. Drive SHERA Plug into the hole



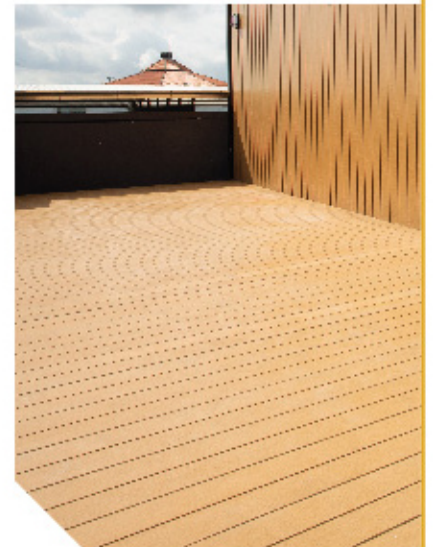

## Loading table of **SHERA** Floor Plank

Concentrated Load /

Point Load (kg) - 100 mm. x 100 mm. foot print

Joist Spacing (mm.)	Allowable Concentrated Load (kg.)		
	Width of Product (mm.)		
	150	200	300
200	175	234	350
300	117	156	234
400	-	93	139
500	-	-	89

Uniform Load (kg/m<sup>2</sup>)

Joist Spacing (mm.)	Allowable Concentrated Load (kg.)		
	Width of Product (mm.)		
	150	200	300
200	11,680	11,680	11,680
300	4,405	4,405	4,405
400	-	1,658	1,658
500	-	-	951

- Remark : 1) Apply on Shera Floor Plank products with 25 mm. thickness and 3 meter length  
 2) Products shall be installed on raised structural frames  
 3) Prior installation, all sizes of surfaces shall be coated with primer and top coats  
 4) Loading requirement shall be provided by engineer, and verify to loading table recommended above  
 5) All support framing / joists to be designed and endorsed by qualified engineer. Shera shall not reliable  
 6) Table above is designed with safety factor of 2.0

\*Colors of products shown in pictures may differ from the actual products due to printing system.

**NEW**

# SHERA Floor Plank Clip-Lock Series

- ✓ Smooth & Beauty with no screw head
- ✓ Fast and Easy to Install by Clip-Lock system
- ✓ Weather Resistance



\*Colors of products shown in pictures may differ from the actual products due to printing system.

## Product Information

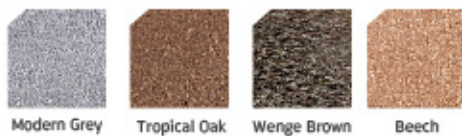

Profile	Color	Texture	Size (cm.) (Thickness*Width*Length)	Weight (kg./pc.)	Quantity (pc./sq.m.)
V-Cut Edge	Modern Grey	Straight Grain	2.5 x 15 x 300	16.93	2.22
	Wenge Brown				
	Tropical Oak				
	Beech		2.5 x 20 x 300	22.81	1.67

\*Wenge Brown and Tropical Oak are available in Color Through.

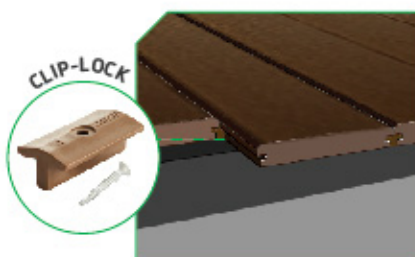

## SHERA Clip-lock

### Product Information

Product	Weight (kg./box)	Quantity (pcs./box)
SHERA Clip-Lock Installation set	0.2	36





\*Colors of products shown in pictures may differ from the actual products due to printing system.

## SHERA Stair

Get your home safe for every step with **SHERA Stair** that will provide you the beauty of real wood texture and, for the first time ever, the highest thickness option that goes up to 3.5 cm., only possible with **SHERA** innovation. That's why **SHERA Stair** is so great at supporting heavy loads. Besides its toughness and wood-like beauty, **SHERA Stair** also comes with the ease of installation to make the most out of its strength, the ability to be applied to metal frame or concrete frame, and extensive options to suit the design of your choice.



### SHERA Stair Color Through Anti Slip

Be safe everywhere with our special anti-slip coating that enhances slip-resistant performance on the wood surface. This helps reduce the risk of slipping and falling off the stairs even when your feet are wet, so you can stay confident and worry free.

### Product Information

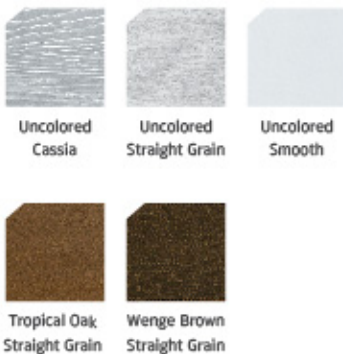

	Profile	Texture	Color	Size (cm.) (Thickness*Width*Length)	Weight (kg./pc.)
Stair Tread	Curved edge	Cassia		2.5 x 25 x 120	11.82
				2.5 x 30 x 120	14.19
				3.5 x 25 x 120	16.56
				3.5 x 27 x 120	17.89
				3.5 x 30 x 120	19.88
Stair Tread	Curved edge	Straight Grain	Uncolored	2.5 x 25 x 120	11.82
				3.5 x 27 x 120	17.89
				3.5 x 30 x 120	19.88
Stair Riser	Square-cut edge	Smooth		1.6 x 15 x 120	4.48
				1.6 x 20 x 120	5.97
Anti Slip Stair Tread	Curved edge	Straight Grain	Tropical Oak	2.5 x 25 x 120	11.82
			Wenge Brown	2.5 x 25 x 120	11.82
Anti Slip Stair Riser	Square-cut edge	Straight Grain	Tropical Oak	1.6 x 20 x 120	5.97
			Wenge Brown	1.6 x 20 x 120	5.97

Remark: \*\*Made to order item SHERA Stair Riser is only available in smooth texture





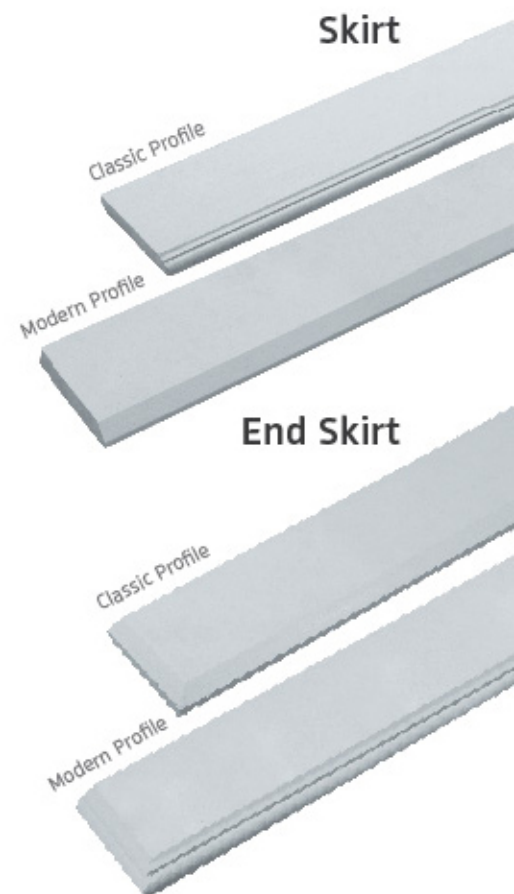

## SHERA Skirt

Cover joints between the wall and the floor with **SHERA Skirt** and enhance the feelings of nature in your home with texture and color of real wood. **SHERA Skirt** comes with great properties ensuring durability, termite free, no rotting and no swelling from excess moisture. Using **SHERA Skirt** as a baseboard will not only help prevent stains on the wall while cleaning, but also give a neat and beautiful finish to your design.



### Product Information



	Profile	Texture	Color	Size (cm.) (Thickness*Width*Length)	Weight (kg./pc.)
Skirt	Classic 	Smooth	Uncolored	1.2 x 10 x 300	5.33
	Modern 				
End Skirt	Classic 	Smooth	Uncolored	1.2 x 10 x 100	1.83
	Modern 				



*Installing skirts along stair steps not only creates a beautiful finish along the edge but also gives visual cues on a flight of stairs, keeping everyone in your home safe.*

# SHERA Floor Board

It's time to take fiber cement flooring innovation to the next level with *SHERA* Floor Board. By being of better quality than any other wood-chip cement boards or typical plywood, *SHERA* Floor board can ensure durability in any weather conditions, resistance to water-fire-termites as well as the ability to support heavier weight, thus it can be a perfect flooring material throughout the building. Save your time and money by choosing floorboard that's designed for a quick installation. Plus you can conveniently apply *SHERA* Floor Board as a substrate for various finishings as well.

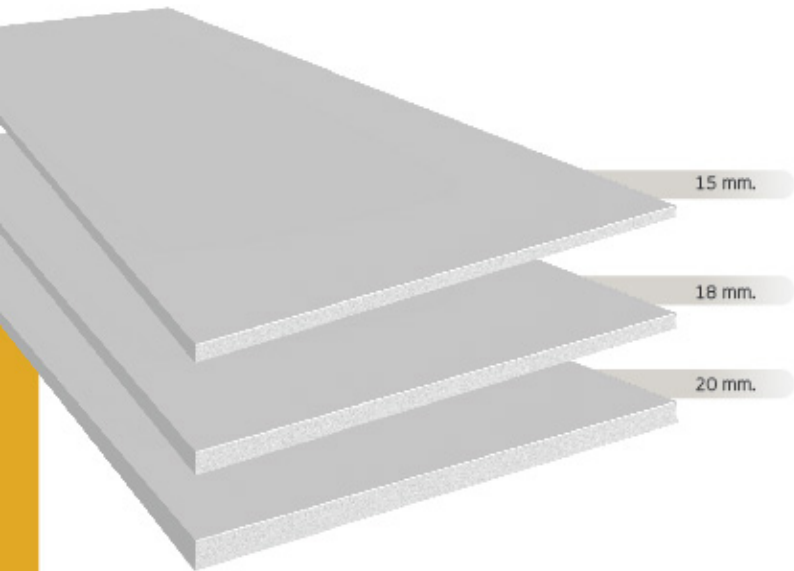

## Product Information

<i>SHERA</i> Floor Board	Size (cm.) (Thickness*Width*Length)	Weight (kg./pc.)	Quantity (pc./sq.m.)	Application Area
Square Cut Edge For underlayment	0.8 x 122 x 244	37.26	0.34	indoor underlayment
	1.0 x 122 x 244	46.58		
	1.2 x 122 x 244	55.89		
Square Cut Edge For elevated floor	1.5 x 122 x 244	69.32	0.34	indoor and outdoor elevated floor
	1.8 x 122 x 244	83.19		
	2.0 x 122 x 244	92.43		

\*Available in metric size.





## Table showing weight tolerance of **SHERA** Floor Board for one-way slab

Uniform distribution load

kg./sq.m.	Joint spacing for one-way slab calculated with a factor of safety of 2.5			
SHERA Board's thickness	30 cm.	40 cm.	50 cm.	60 cm.
15 mm.	1,300	700	400	-
18 mm.	1,900	1,000	600	400
20 mm.	2,300	1,300	800	500

## Table showing weight tolerance of **SHERA** Floor Board for two-way slab

Uniform distribution load

kg./sq.m.	Joint spacing for two-way slab calculated with a factor of safety of 2.5					
SHERA board's thickness	30x30 cm.	30x40 cm.	30x60 cm.	40x40 cm.	40x60 cm.	60x60 cm.
15 mm.	1,600	1,200	900	900	600	400
18 mm.	2,400	1,700	1,300	1,300	900	600
20 mm.	3,000	2,200	1,600	1,600	1,100	700

- Remarks:
- 1.) Maximum point load for foot print of 30 cm x 30 cm is 150 kg for SHERA raised flooring system. Support spacing should be controlled within 610 mm maximum.
  - 2.) For one-way support, SHERA floor board shall be arranged its length direction perpendicular to frame direction.
  - 3.) Do not install while SHERA Floor Board is wet.

# *Decorative Application*





# **SHERA™**

build better, live better

A variety of fiber-cement products are provided to create a better living experience. Creative innovations eliminate the limitations of natural wood for internal and external decoration.

- *SHERA* Vent Board
- SHERA* Baluster
- SHERA* Fence
- SHERA* Décor Wood





## SHERA Vent Board

Various perforated boards are suitable for decoration as partitions, wall opening, and ventilation opening, creating impressive design to any part of the house.

### Product Information



Uncolored  
Smooth Texture

Profile	Texture	Color	Size (cm.) (Thickness*Width*Length)	Weight (kg./pc.)
Nepal Trumpet	Smooth	Uncolored	1.0 x 60 x 200	11.71
Blossom			0.8 x 60 x 120	7.30
Paragon			1.0 x 30 x 152	3.83
Liana			1.0 x 49 x 104	5.33
Heart (Small)			0.8 x 45 x 90	3.73
Heart (Big)			0.8 x 70 x 90	6.08
Louise			0.8 x 60 x 60	2.84
Fountain Plant			1.0 x 60 x 60	4.15

Nepal Trumpet



Blossom



Paragon

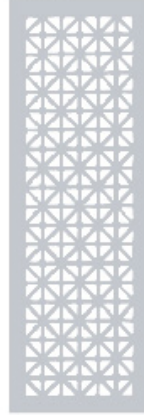

Liana



Louise



Fountain Plant



Heart (Big-Small)



## Product Information

# SHERA Baluster

Perforated wood for handrail and terrace edge decoration.  
Not erosive due to climate despite external installation.



Uncolored  
Smooth Texture



Rose



Lily

Size (cm.) (Thickness*Width*Length)	Weight (kg./pc.)	
	Rose, Smooth texture Uncolored	Lily, Smooth texture Uncolored
1.2 x 15 x 80	2.10	1.80



SHERA The leader of perforated pattern on fiber-cement materials

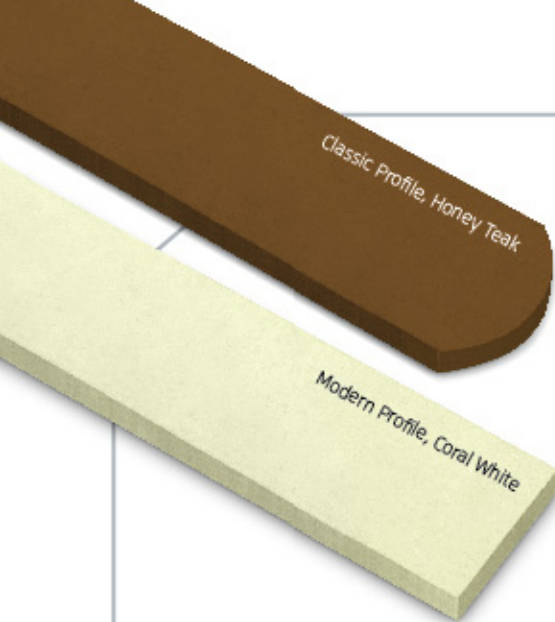

## SHERA Fence

Creating new styles of fence and decorative work, it is easy to install on wood and steel frame, not bending, twisting and decay. There area variety of choices for perfect fence decoration.



*Shine Light  
Timeless Beauty*

## SHERA Shine Light Fence

The latest products from SHERA with innovative shining colors like natural wood. It is uniquely strong and weather resistant, dust free and less maintenance needed.

### Product Information



Profile	Texture	Color	Size (cm.) (Thickness*Width*Length)	Weight (kg./pc.)
Modern	Smooth	Uncolored	1.2x 10 x 300	5.33
		Coral White / Honey Teak	1.6 x 10 x 150	3.74
Classic	Smooth	Coral White	1.6 x 10 x 150	3.71
		Honey Teak	1.6 x 10 x 100	2.46
Classic	Straight Grain	Redberry Shine Light	1.6 x 10 x 100	2.46
		Red Oak Shine Light	1.6 x 10 x 100	2.46
		Oak Shine Light	1.6 x 10 x 100	2.46
Modern	Straight Grain	Oak Shine Light	1.2x 10 x 300	5.34
		Red Oak Shine Light	1.2x 10 x 300	5.34

 **Thicker, stronger, more durable**

 **Pre painted, beautiful in all respects**  
*(2-layered coating, painted on all sides)*

 **Fast, ready to install**

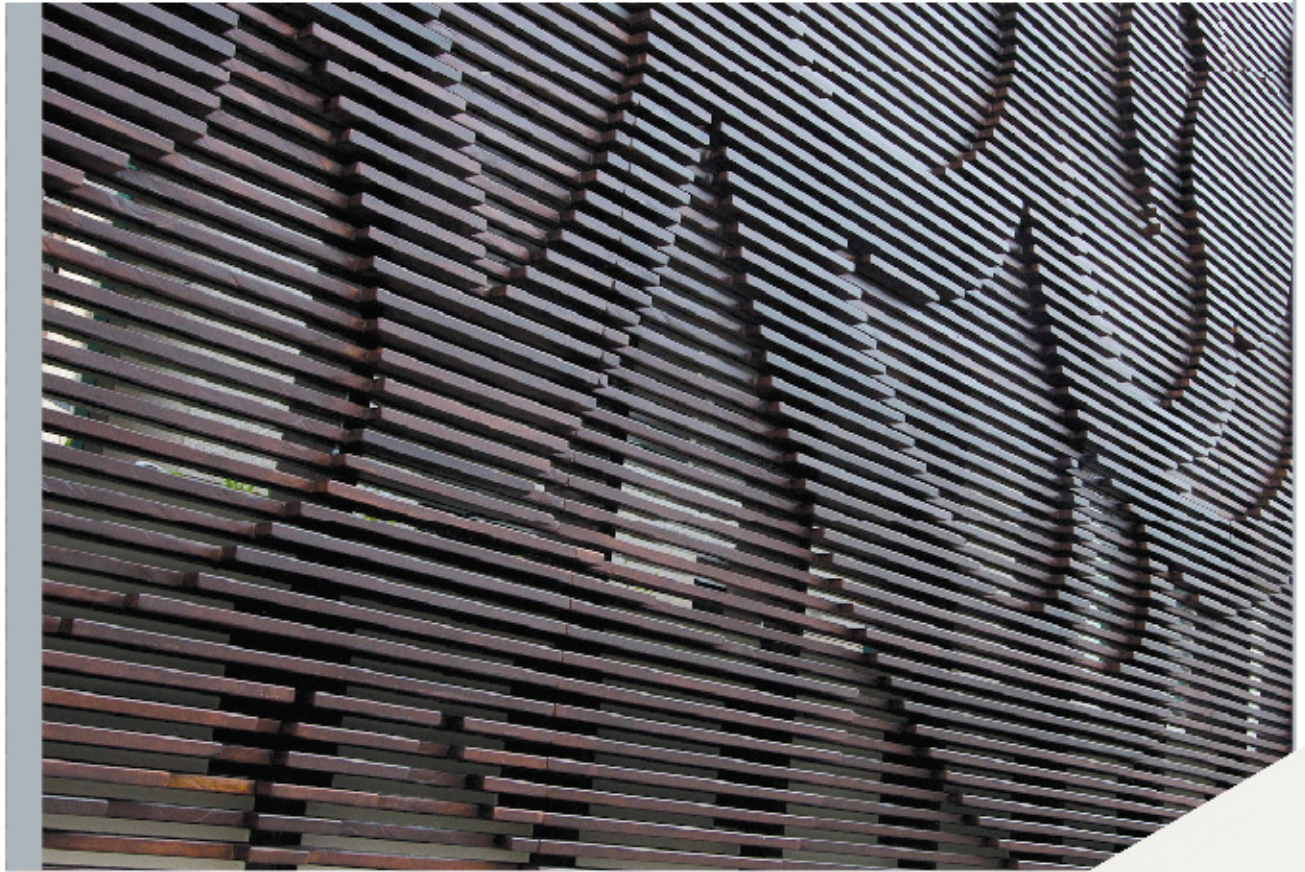

## SHERA Décor Wood

Generating a variety of modern building decoration. It can be used as blinds to fulfill all needs and gives the natural wood feeling.



*A wide range of sizes to meet all preferences. SHERA provides the most choices of décor wood the suits your taste.*

Cassia Texture

Smooth Texture

Straight Grain Texture

### Product Information

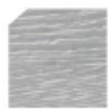

Uncolored Cassia Texture



Uncolored Smooth Texture



Uncolored Straight Grain Texture

Texture	Color	Size (cm.) (Thickness*Width*Length)	Weight (kg./pc.)	Quantity (pc./sq.m.)
Cassia	Uncolored	1.6 x 7.5 x 300	5.60	4.44
		2.5 x 5.0 x 300	5.92	6.72
		2.5 x 10 x 300	11.83	3.33
Smooth	Uncolored	1.6 x 5.0 x 300	3.74	6.67
		1.6 x 7.5 x 300	5.60	4.44
Straight Grain	Uncolored	2.5 x 5.0 x 300	5.92	6.67

# *Roof Application*



# **SHERA™**

build better, live better

With the unique properties beyond the natural wood in terms of weather resistance, low stretching and shrinkage, and no bending as well as a variety of colors, sizes and profiles, Sera's roofing application products can meet various requirements, especially for external works with outstanding contemporary and modern designs.

- *SHERA Zedar Shake*
- SHERA Eaves*
- SHERA Eaves Pro*
- SHERA Eaves One Plus*
- SHERA Eaves Filler Unit*
- SHERA Eaves Drop*
- SHERA Eaves Lace*

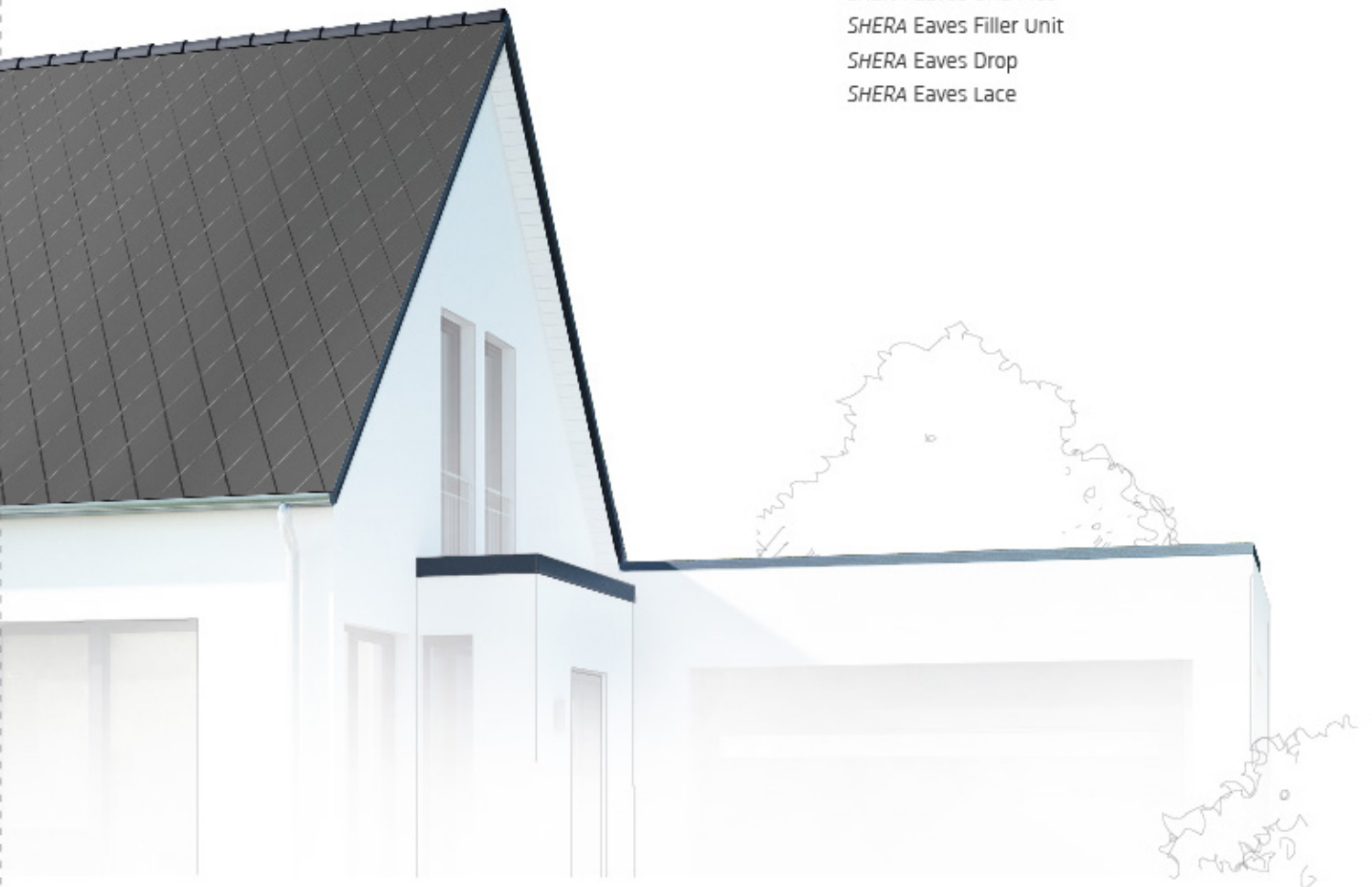

## **SHERA** Zedar Shake



*Inspired by  
The Beauty  
of **Nature***

Add a touch of natural beauty to your roof design with **SHERA** Zedar Shake, an innovative roof material that holds the natural look and beautiful texture of real wood. **SHERA** Zedar Shake possesses the finest quality, well-known durability guaranteed by high quality manufacturing processes, termite resistant property and Inter-Locking system, water leakage prevention system certified by ASTM C1530-04 Standard. You can rest assured that sub roof is not needed, installation time and cost will be lower, and maintenance is minimal.

Bring a little charm to your wood-like roof with our 'Color Through' technology, the method we use to pigment color thoroughly and evenly into the product. There're 3 shades of dark colors to be chosen from: Yellow Zante, Brown Chestnut and Black Wenge along with 3 tile widths to fit your design. Therefore it's easy for any designer and owner to craft their masterpiece home or building projects which are truly a feast for the eyes.



Site Reference







### *Yellow Zante* 481

This is one of the bark themed colors that comes in a light yellowish shade, giving a sense of gentle and warm touch of nature like a color of pine trees in the summer or the warm light of the sun. And with the bark texture combined, this is a perfect way to fill your home with warmth and relaxation every day.



### *Brown Chestnut* 482

Calm and comfort blend perfectly in this natural shade from our bark themed colors, designed by drawing out the beauty of pine trees in the rainy season. Pine trees turn into darker shade due to humidity in rain forest. This color will make your time at home feel even more peaceful, relaxing, and appealing.



### *Black Wenge* 483

This dark shade of bark color comes with hidden charm and strength just like pine trees during winter. With the presence of white snow, the dark color creates contrast on the roof. And this sense of elegance and solemn is what makes your roof more attractive and stand out.



### *Metro Grey* 484

This grey color represents coolness and luxury of metropolis. Inspired by worn out cedar roof, stain and uneven color is enhanced with grey color gradient to create the perfect harmony between nature and civilized society.



## Product Information

*SHERA* Zedar Shake Roof Quantity Per 1 Box (Usage quantity: 0.8 sq.m./box)

Width	Length	Thickness	Weight/pc.	Quantity per box
10 cm.	35 cm.	12 mm.	0.75 kg.	5 pcs
15 cm.	35 cm.	12 mm.	1.19 kg.	10 pcs
20 cm.	35 cm.	12 mm.	1.47 kg.	10 pcs



20x35 cm. 15x35 cm. 10x35 cm.

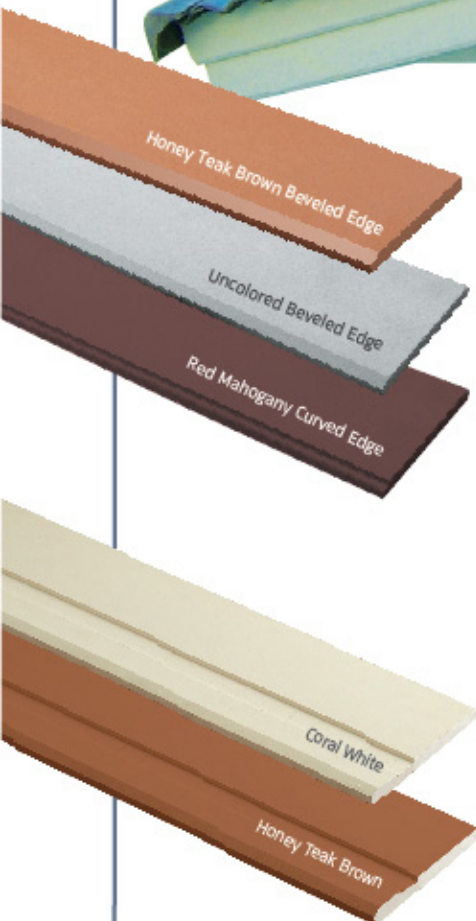
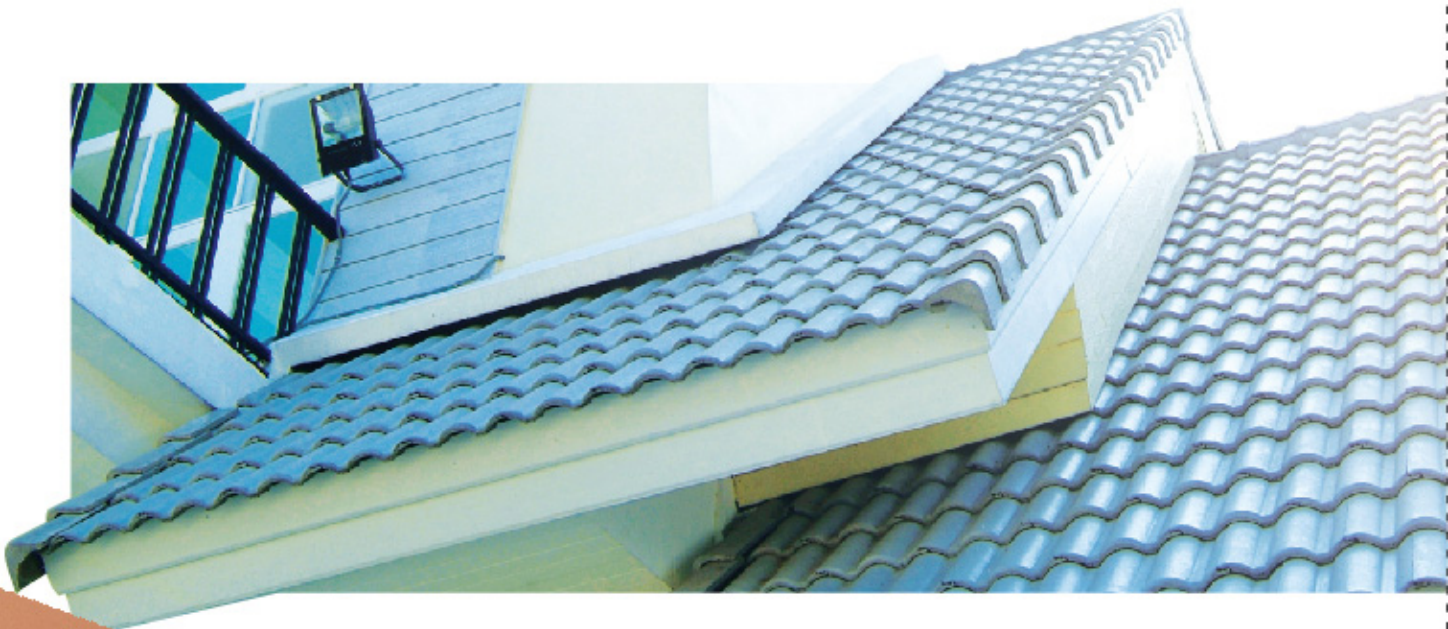

## SHERA Eaves

Complete your home design with **SHERA Eaves**, a roof finishing product that adds a beauty touch to your home along with strength in everyday weather. It also withstands termites, beetles, insects and is not likely to shrink or twist. **SHERA Eave** is a perfect material for important spots that are difficult to maintain. With modern Beveled Edge and classic Curved Edge, you can choose the best feature for your home design.



*Take your home's eave design to the next level with this curved edge profile that will externalize your individuality through luxury.*

## SHERA Eaves Pro

Take a roof eave to the next level with **SHERA Eaves Pro** which is made from innovative materials for the fastest and most convenient construction. From a well-designed feature with beautiful grooving to a lightweight property and pre-painted finish out of factory, **SHERA Eaves Pro** is complete in itself and ready for a quick install. Once installed, **SHERA Eaves Pro** will help create a cozy atmosphere to your home for a long time due to its durability and resistance to heat, humidity, swelling and bending.

### Product Information

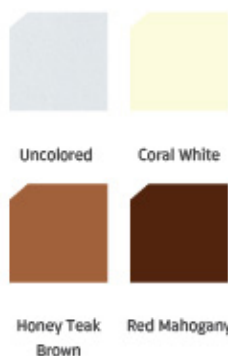

Profile	Texture	Color	Size (cm.) (Thickness*Width*Length)	Weight (kg./pc.)
Beveled Edge	Smooth	Uncolored	1.6 x 15 x 300	11.03
		Coral White	1.6 x 20 x 300	14.77
		Honey Teak Brown	1.6 x 15 x 400	14.71
		Red Mahogany	1.6 x 20 x 400	19.69
Curved Edge	Smooth	Uncolored	1.6 x 15 x 300	10.99
		Coral White	1.6 x 20 x 300	14.73
		Honey Teak Brown	1.6 x 15 x 400	14.65
		Red Mahogany	1.6 x 20 x 400	19.64
Pro	Smooth	Coral White	1.6 x 24 x 300	17.05
		Honey Teak Brown	1.6 x 24 x 400	22.73
		Merbau Brown	1.6 x 24 x 300	17.05
Senepa*	Smooth	Red Mahogany	1.6 x 24 x 400	22.73
		Uncolored	1.2 x 25 x 244	10.31
			1.2 x 30 x 244	13.90

\*Available in Philippines only



## SHERA Eaves One Plus

This is the kind of eaves designed for roof decoration aiming for a “beautiful, durable and quick” finish. Cover joints between two materials and hide the untidy cut ends of roofs’ rafters and sheathing with eaves that are ready to use and complete in one step.

**SHERA Eaves One Plus** is beautifully designed to mimic the appearance of 2 overlapping planks, creating dimensions for each piece. The texture is tough and non-brittle. Thickness options include 16 mm. and 22 mm. with the length options between 3 and 4 meters.



*SHERA Eaves One Plus can reduce installation process from two steps down to one (compared to normal eaves installation)*



### DIAMOND CUT Technology

with Computer Numerical Control (CNC) makes cutting process precise and ensures all planks meet exact specifications.

## Product Information



Uncolored



Red Mahogany

Profile	Texture	Color	Size (cm.) (Thickness*Width*Length)	Weight (kg./pc.)
One Plus 	Smooth	Uncolored	1.6 x 23.5 x 300	15.29
			1.6 x 23.5 x 400	20.39
		Red Mahogany	2.2 x 23.5 x 300	21.33
			2.2 x 23.5 x 400	28.45
			2.2 x 23.5 x 300	21.33
			2.2 x 23.5 x 400	28.45

## SHERA Eaves Drop

Represent Thai beauty with **SHERA Eaves Drop**, an ornately carved wood panel that combines the feature of eave and gable with elegant style. Crafted from Water Jet technology on a fiber cement, the pattern is delicate and beautiful throughout. And since **SHERA Eaves Drop** will serve as an outdoor material, it comes with durability under any weather condition as well as resistance to water, sunlight, rain, termite, insects, beetles, twist and shrinkage over a lifetime.



Teak Texture Classic Profile



Teak Texture Puang Thong Profile



Teak Texture Golden Bell Profile

### Product Information



Uncolored  
Teak Texture

Profile	Texture	Color	Size (cm.) (Thickness*Width*Length)	Weight (kg./pc.)
Classic	Teak	Uncolored	0.8 x 15 x 30	0.36
			0.8 x 15 x 50	0.70
Puang Thong			0.8 x 15 x 30	0.42
			0.8 x 15 x 50	0.64
Golden Bell			0.8 x 15 x 30	0.41
			0.8 x 15 x 50	0.75



## SHERA Eaves Lace

Make your home an impressive place for family members and visitors with **SHERA Eaves Lace**, a stunning fretwork panel for decorating along the eaves. It's made from highly durable material ideal for outdoor application integrated with long-lasting resistant properties to water, sunlight, rain, termites, beetles, insects, twist and shrinkage.

**SHERA Eaves Lace** comes with several shades and beautiful patterns to choose from in accordance with your designs. Let these materials and designs define your home identity in a stylish manner.



Teak Texture Lotus Profile



Teak Texture Tulip Profile



Teak Texture Alamanda Profile



Smooth Texture Sky Flower Profile



Smooth Texture Heart Profile

### Product Information



Uncolored  
Teak Texture



Uncolored  
Smooth Texture

Profile	Texture	Color	Size (cm.) (Thickness*Width*Length)	Weight (kg./pc.)
Lotus	Teak	Uncolored	0.8 x 20 x 100	1.42
Dokrak			0.8 x 20 x 100	1.76
Tulip			0.8 x 20 x 100	1.56
Alamanda			0.8 x 20 x 100	1.68
Sky Flower	Smooth		0.8 x 20 x 100	1.64
Heart			0.8 x 30 x 100	2.83

# Technical Data

## SHERA Wood

Properties	Standard	Unit	•SHERA Plank •SHERA Strip, Teak Texture	•SHERA Splendid Plank	•SHERA Skirt •SHERA Laminate Skirt •SHERA Fence •SHERA Baluster	•SHERA Ceiling Skirt	•SHERA Strip, Smooth Texture •SHERA Strip, Straight Grain Texture	16 mm thick •SHERA Eaves •SHERA Stair Tread •SHERA Décor Wood	•SHERA Filler Unit	25 mm thick •SHERA Floor Plank •SHERA Décor	•SHERA Floor Plank 30 mm thick •SHERA Stair Tread	•SHERA Door Frame
------------	----------	------	---	-----------------------	--	----------------------	--	--	--------------------	---	--	-------------------

### Physical Properties

1. Thickness tolerance	ASTM C1185	mm.	+/- 0.50	+/- 0.60	+/- 0.72	+/- 0.48	+/- 0.48	+/- 0.96	+/- 0.50	+/- 1.50	+/- 2.0	+/- 2.0
2. Density	ASTM C1185	kg.m <sup>3</sup>	1300-1400	1250-1350	1300-1400	1300-1400	1300-1400	1300-1400	1300-1400	1300-1390	1300-1390	1300-1390
3. MOR ( <i>avg</i> )	ASTM C1185	MPa	-	≥ 9 (WET)	-	-	-	-	-	-	-	-
4. MOR (MD)	ASTM C1185	MPa	-	-	≥ 12 (EMQ)	≥ 12 (EMQ)	-	≥ 12 (EMQ)	-	≥ 11 (EMQ)	≥ 11 (EMQ)	≥ 11 (EMQ)
5. Toughness (MD)	-	J/m <sup>2</sup>	≥ 12 (EMQ)	-	≥ 10 (EMQ)	≥ 7 (EMQ)	≥ 12 (EMQ)	≥ 10 (EMQ)	≥ 9 (EMQ)	≥ 12 (EMQ)	-	n.a.
6. Water Absorption	ASTM C1185	%	≤ 35	≤ 35	≤ 35	≤ 35	≤ 35	≤ 35	≤ 35	≤ 35	≤ 35	≤ 35
7. Moisture	ASTM C1185	%	≤ 15	≤ 15	≤ 15	≤ 15	≤ 15	≤ 15	≤ 15	≤ 15	≤ 15	≤ 15
8. pH value	ISO 10390:2005		7	7	7	7	7	7	7	7	7	7

### Fire Resistance Properties

9. Non-inflammability	BS476 Part 4		Pass	Pass	Pass	Pass	Pass	Pass	Pass	Pass	Pass	Pass
10. Inflammability	BS476 Part 5		Pass	Pass	Pass	Pass	Pass	Pass	Pass	Pass	Pass	Pass
11. Fire Propagation Index	BS476 Part 6		Pass	Pass	Pass	Pass	Pass	Pass	Pass	Pass	Pass	Pass
12. Surface Spread of Flame	BS476 Part 7		Pass	Pass	Pass	Pass	Pass	Pass	Pass	Pass	Pass	Pass

### Durability Properties

13. Freeze / Thaw Resistance	ASTM C1185		Pass	Pass	Pass	Pass	Pass	Pass	Pass	Pass	Pass	Pass
14. Warm Water Resistance	ASTM C1185		Pass	Pass	Pass	Pass	Pass	Pass	Pass	Pass	Pass	Pass
15. Heat / Rain Resistance	ASTM C1185		Pass	Pass	Pass	Pass	Pass	Pass	Pass	Pass	Pass	Pass
16. Soak / Dry Resistance	BS EN 12467		Pass	Pass	Pass	Pass	Pass	Pass	Pass	Pass	Pass	Pass

### Testing Institutions



ASTM C 1185 - 91  
AS/NZS 2908.2 - 2000  
ISO 9001:1993



# Installation Guides

## SHERA Wood

### SHERA Floor Plank Installation on timber/steel frame structure with screw



Fix *SHERA* floor plank that has been finished on all six sides with a primer to steel structure using *SHERA* Screw Fix-W45 (Use *SHERA* Screw Fix-T1 3/4" for timber structure). Fasten both sides of *SHERA* floor plank, or on the middle for the 6" / 8" wide plank, to the joist by using screw along the length of the plank.

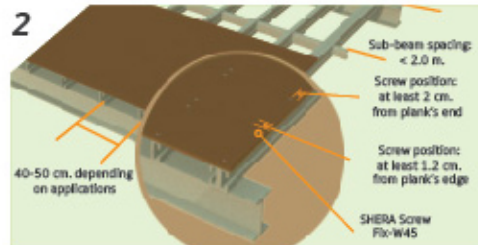

Screw positions should be at least 1.2 cm from *SHERA* floor plank's edge, and at least 2 cm from *SHERA* floor plank's end.

**Remark :** - Fasten the screws so that screw heads are flush evenly with *SHERA* floor plank's surface.

- Wherever on-site cutting applied to the product, the cut surface must be painted with equivalent water based coating system prior installation in order to prevent water/moisture absorbed into product. Ensure proper covering of the coating over the product for best performance

### Installation *SHERA* Eaves



Install an 8" wide plank to the roof frame.



Install a 6" wide plank by overlapping with the 8" wide installed previously.

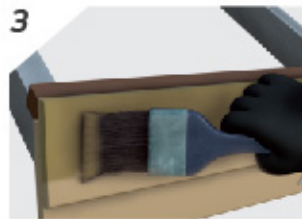

Apply primer.



Apply paint color.

### Installation *SHERA* Eaves One Plus

"Complete the installation in one quick step by fixing two screws at each point at the end of rafter"



### Tips on how to paint *SHERA* Wood

#### Instructions

1. Prepare and clean the wood surface.

Cement Color Primer Color Uncolored

2. Apply *SHERA* Primer for old fiber cement on all 6 sides 1 time.

3. Apply *SHERA* Paint for fiber cement in transparent or monotone color 2 times.

4. Apply *SHERA* Top Guard to achieve a matte or glossy finish (suitable for floor plank or floor that require a high protection) 1-2 times.



1



2



3



4

## SHERA Tools and Equipment



### SHERA Corner Piece, Smooth Texture

For internal and external wall cornering  
Size (cm): 0.6 x 8 x 305



### SHERA Sealant PU 25

For jointing gaps  
SHERA Product Packing 310/600 ml

### SHERA Barrel Gun

For using with SHERA Sealant PU 25  
For both 310 ml and 600 ml



### SHERA Screw FIX-W

Screws for installing SHERA wood to wood sub flume. Screw heads are embedded firmly into the wood to create neater finish than conventional screws.

#### Quality Class: 2

Length (inch): 1 ½ and 1 ¾  
Diameter: No. 8

#### Packing

FIX-W32GB = 500 pcs/box  
FIX-W45GB = 250 pcs/box



### SHERA Plug

Perfect your floor without having to touch up screw heads with this new approach.

**Packing** : 250 pcs/box

### SHERA Plug Consumption

Frame Spacing	SHERA Floor Plank Color Through	Area Coverage( m <sup>2</sup> /box )
30 cm	2.5x15x300 cm.	10
	2.5x20x300 cm.	6.5
40 cm	2.5x15x300 cm.	8
	2.5x20x300 cm.	12.5



### SHERA Acrylic Paint

Available for all colors for painting screw heads and wood cutting  
Packing 0.525 liter Application quantity 10 sq.m./liter



### SHERA Screw FIX-T

Screws for installing SHERA wood to wood sub flume. Screw heads are embedded firmly into the wood to create neater finish than conventional screws.

#### Quality Class: 2

Length (inch): 1 ½ and 1 ¾  
Diameter: No. 8

#### Packing

FIX-T 1½ = 500 pcs/box  
FIX-T 1¾ = 250 pcs/box

Characteristics of frames	SHERA Plank / SHERA Splendid Plank SHERA Skirt and SHERA Strip	SHERA Eaves (lower unit)	SHERA Eaves (upper unit)	SHERA Floor Plank and SHERA Decor Wood
Installation on steel frame	SHERA screws FIX-W32GB	SHERA screws FIX-W32GB	SHERA screws FIX-W45GB	SHERA screws FIX-W45GB
Installation on wood frame	SHERA screws FIX-T 1½"	SHERA screws FIX-T 1½"	SHERA screws FIX-T 1¾"	SHERA screws FIX-T 1¾"

## SHERA Wood Storage



- Do not stack SHERA Wood Product more than 100 cm high and a piece of wood should be put under SHERA wood product each 50 cm height along the width of SHERA Wood Product.
- SHERA Wood Product should be stacked in a dry, flat place and covered with canvas or plastic to ensure equilibrium moisture content prior to installation. Do not install SHERA wood Product in wet condition as it may cause cracks due to stretching or shrinkage at the gaps screw or nail holes.



# Technical Data

## SHERA Board

Physical Properties	Standard	Unit	Test Result
Thickness Tolerance	ASTM C1185	%	± 6%
Density	ASTM C1185	Kg/cm <sup>3</sup>	1350 ± 50
Modulus of Rupture	ASTM C1185	Mega Pascal	> 7 MPa (Wet)
Modulus of Elasticity	-	Mega Pascal	> 3000 MPa (Wet)
Water Absorption	ASTM C1185	%	< 35%
Moisture Content	ASTM C1185	%	< 15%
PH Value	-	-	7-8
Thermal Conductivity	ASTM C177	Watt/m Kelvin Degree	0.15 W/m.K
Acoustic Insulation	ASTM E90-97	Decibel	STC = 30 dB (6 mm single board) STC = 50 - 60 dB (10 mm composite wall)
Moisture Movement	ASTM C1185	%	+ 0.04%
Length change due to water absorption	JIS A5414	%	< 0.10 %
Water Tightness	ASTM C1185	-	Pass
Fire Resistance Properties			
Ignitibility	BS476 Part 5	-	Pass
Fire Propagation Index	BS476 Part 6	-	I = 0.4
Surface Spread of Flame	BS476 Part 7	-	Class 1
Fire resistance of partitions	BS476 Part 22	minute	30-180
Smoke Index	ASTM E84-00a	-	0
Single Burning Item	EN 13823 : 2002	-	Pass
Fire Classification	EN 13501-1 : 2002	-	A2-s1,d0
Building Combustibility	CNS 6532	-	non-combustibility
Durability Properties			
Freeze/Thaw resistance	-	-	Pass
Warm water resistance	ASTM C1185	-	Pass
Heat/Rain resistance	and BS EN 12467:2000	-	Pass
Soak/Dry resistance	BS EN 12467:2000	-	Pass

\*Remark : SHERA BOARD has passed the test by Australia/New Zealand Standard (AS/NZ 2908:2:2000) and EU Standard (BS EN 12467: 2000) by PSB Corporation Singapore and TIS 1427-2540 certifying fiber-cement tiles in Thailand.

### Bend Radius

SHERA Board is tough and highly flexible, bendable without applying water.

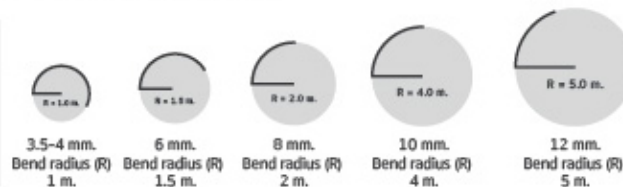

Horizontal bend radius of the board of each thickness

### Selection for Application

Types of Application	Thickness (mm)								
	3.5	4	6	8	10	12	15	18	20
Interior ceiling	●	●							
Eaves/Ceiling/Arch			●						
Bending Wall/Interior Partition			●	●					
Subroof/Sunshade			●	●	●				
General exterior wall/Wet area				●	●	●			
High-rise building wall/Exterior building board					●	●			
Underlayment				●	●	●			
Raised Floor							●	●	●
Weight (kg/ sq.m.)	5.36	6.12	9.32	12.42	15.52	18.63	22.42	26.91	29.90

### Movement and Piling

Always raise the board vertically by raising the two ends

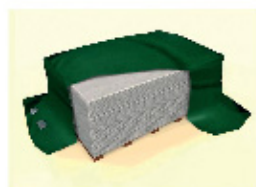

Pile the boards up at shady and on the flat and dry ground. The boards should be supported by 5 pieces of wood of 1.5"x3" wide as indicated in the schedule. Do not install and paint the board in wet condition.

Thickness (mm.)	Piling not exceeding (pcs)
4	300
6	225
8	150
10	120
12	105
15	90
18	75
20	60

# Installation Guides

## SHERA Board

### Floor Installation

Finishing Materials : carpet, ceramic tile, rubber tile, engineered wood and laminate

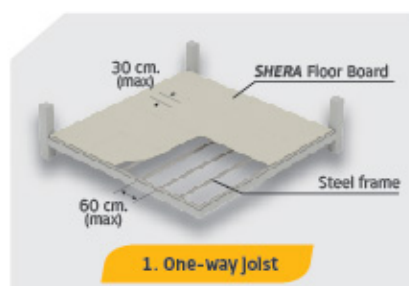

1. One-way joist

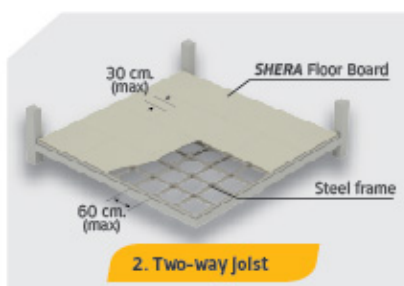

2. Two-way joist

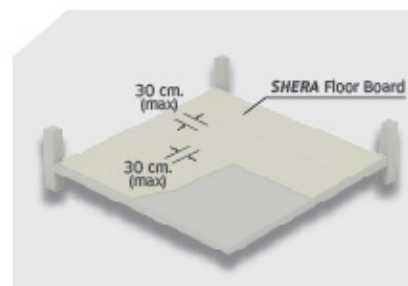

### Elevated floor installation

#### SHERA Board Product

Square-cut edge, 15-20 mm. thick

#### Type of frame

Structural steel frame :

with a minimum thickness of 2.3 mm.

Hardwood frame :

with a minimum dimensions of 1 1/2 x 3 inches

#### Joint Spacing

One-way joist at every 60 cm.

Two-way joist at 60 x 60 cm.

#### Joint Spacing

One-way joist at every 60 cm.

Two-way joist at 60 x 60 cm.

#### Fixing distance

At every 30 cm. with 1.2 cm. distance from the board's edge and 5 cm. from the corner

#### Painting

Apply epoxy for indoor application.

Apply polyurethane for indoor and outdoor application.

### Sub-floor board installation on existing concrete floor

#### SHERA Board Product

Square-cut edge, 8-12 mm. thick

#### Board fixing tools

Use cement adhesive or polyurethane adhesive with hammer and 1-1.5" concrete nails.

#### Fixing distance

At every 30 cm. with 1.2 cm. distance from the board's edge and 5 cm. from the corner

### Wall Installation

Finishing Materials : wallpaper, tile, laminate

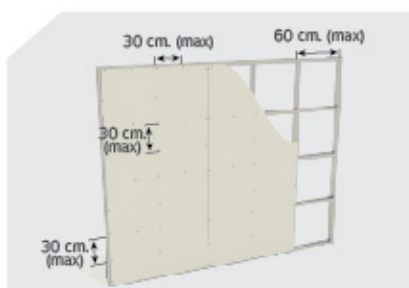

### General wall application

#### SHERA Board Product

Square-cut edge, 6-12 mm. thick for v-groove wall

Recessed edge, 6-12 mm. thick\* for smooth finished wall

#### Type of frame

U75 and C75 galvanized frame with a minimum thickness of 0.55 mm.

#### Joint spacing

60 x 60 cm. or 60 x 120 cm.

#### Fixing distance

At every 30 cm. with 1.2 cm. distance from the board's edge and 5 cm. from the corner

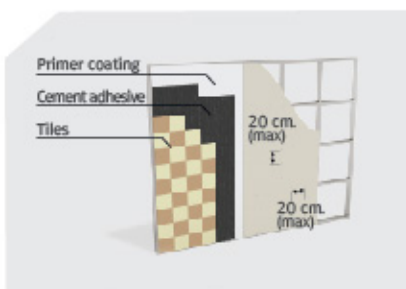

### Tile wall installation

#### SHERA Board Product

Square-cut edge, 10-12 mm. thick

#### Type of frame

U75 and C75 galvanized frame with a minimum thickness of 0.55 mm.

#### Joint spacing

60 x 60 cm.

#### Fixing distance

At every 20 cm. with 1.2 cm. distance from the board's edge and 5 cm. from the corner

#### Ceramic tile fixing tool

Cement adhesive



### Brick wall installation alternative to plaster

#### SHERA Board Product

Square-cut edge, 6-12 mm. thick

Recessed edge, 6-8 mm. thick for interior smooth finished wall

#### Type of frame

C-Line galvanized frame no. 24, 0.55 mm. thick

#### Joint spacing

at every 60 cm. with vertical joint attached to bracket such as BPB ML75

#### Fixing distance

At every 30 cm. with 1.2 cm. distance from the board's edge and 5 cm. from the corner

\* Recessed edge profile 10-12 mm. thick is a made to order item

## Ceiling installation

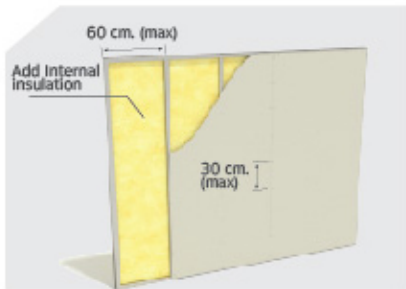

### Sound or thermal insulated wall installation

#### **SHERA Board Product**

Square-cut edge, 6-12 mm. thick

#### **Type of frame**

U75 and C75 galvanized frame with a minimum thickness of 0.55 mm.

#### **Joint spacing**

60 X 240 mm.

#### **Fixing distance**

At every 30 cm. with 1.2 cm. distance from the board's edge and 5 cm. from the corner

#### **Mid-layer material**

Sound or thermal insulation

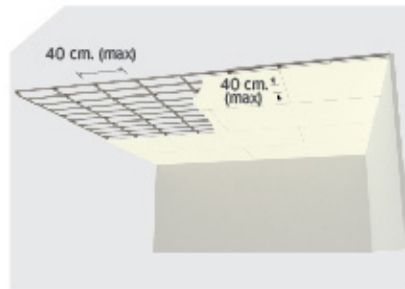

### Steel frame installation

#### **SHERA Board Product**

Square-cut edge, 3.2-6 mm. thick for v-groove ceiling

Recessed edge, 6 mm. thick for smooth finished ceiling

#### **Type of frame**

C-Line galvanized frame no. 24

#### **Joint spacing**

Main section at every 90 cm.  
Cross section at every 40 cm.

#### **Fixing distance**

At every 30 cm. with 1.2 cm. distance from the board's edge and 5 cm. from the corner

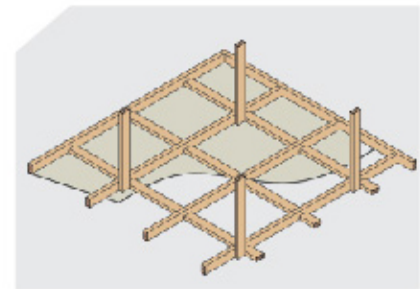

### Timber frame installation

#### **SHERA Board Product**

Square-cut edge, 3.2-6 mm. thick for v-groove ceiling

Recessed edge, 6 mm. thick for smooth finished ceiling

#### **Type of frame**

Hardwood frame with dimensions of 1 1/2 x 3 inches

#### **Joint spacing**

60 cm. x 60 cm.

#### **Fixing distance**

At every 30 cm. with 1.2 cm. distance from the board's edge and 5 cm. from the corner



### Tip on fixing the corners of SHERA Floor, Wall, Ceiling Board

Fix the screw at 1.2 cm. edge distance, with 5 cm. distance from the board's corner

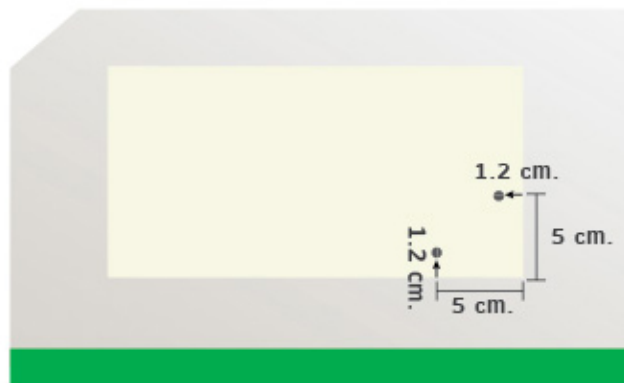

## Tools and Equipment



**Fiber cement cutter**



**Electric screw driver**



**Electric saw**



**Cutter**



**SHERA cement jointing compound**

*SHERA* Cement Jointing Compound  
For exterior and interior work;  
used for plastering joints of  
*SHERA* Wall Board, Recessed edge,  
together with *SHERA* fiberglass  
mesh tape.



**SHERA fiberglass mesh tape**

*SHERA* Fiberglass Mesh Tape  
Used for taping the joints of  
*SHERA* Wall Board, Inclined edge



**SHERA Concrete Bonding Agent**

*SHERA* Flexible Jointing Compound  
Smooth ceiling plastering work  
requiring high flexibility together  
with fiberglass mesh tape



**SHERA sealant PU25**  
For sealing joints of interior  
and exterior works

**SHERA barrel gun**  
Used with Sealant  
Size 310 and 600 ml.

**SHERA screw fix - b**



**SHERA Screw FIX - b**  
For steel structure  
0.55-1.2 mm thick

**SHERA screw fix - w**



**SHERA Screw FIX - w**  
For steel structure  
1-3.2 mm thick

**SHERA screw fix - t**



**SHERA Screw FIX - t**  
For wooden structure

### Schedule of Recommended Fixing of *SHERA* BOARD with *SHERA* Screws

Structure Type	<i>SHERA</i> Screws to be used with <i>SHERA</i> BOARD having several thickness (mm)			
	3.2-6 mm.	6-8 mm.	10-12 mm.	15-20 mm.
<i>SHERA</i> BOARD Thickness				
Galvanized steel structure 0.55-1.0 mm thick	FIX-B20	FIX-W20	FIX-W25	Not recommended
Structural steel 1.0-3.2 mm thick	Not recommended	FIX-W25	FIX-W32	FIX-W45
Wooden structure	FIX-T11/4"	FIX-T11/4"	FIX-T11/4"	FIX-T11/4"

# SHERA Zedar Shake installation

## Product Standards

Ultimate Strength (Bending Stress)	Minimum 1,700 N/m.
Impact Strength (Crack)	2,500 N/m., prior to water submission testing
Water proof property	No water droplets appears under the roof tile surface as specified by ASTM C1492-03
Frost Resistance (Specific Material)	Pass the test (Grade 2 = 100 rounds)
Durability	Passed 50 cycles of HRT with no visible cracks

## Installation Techniques

	Straight Sheet Installation	Overlapped Sheet Installation
Length of Purlin	20 cm.	20 cm.
Overlap	15 cm.	13-17 cm.

**\* Notes :** The tests for leakage of water and impact strength were conducted according to the industrial standards for Fiber Cement Roof product category. The roof tiles went under 24 hours of water submission to test for leakage of water. Prior to that, impact strength tests were conducted to compare the impact strength before and after 24 hours of water submission. Afterwards, the tiles underwent another impact strength test to determine the strength of fiber cement tiles.

To ensure the beauty and maximum efficiency of the roof, please use our installation service.

## Inter-Lock System Installation Techniques

Beyond its beauty and natural perfection, **SHERA** Zedar Shake comes with a development on Inter-Lock system that provides great benefits to home building. With ASTM C1530-04 certified, roofing underlay is no longer necessary to prevent water leakage. **SHERA** Zedar Shake is also cost efficient and encourages creativity in tile arrangements, so you can take your roof design as far as imagination takes you.

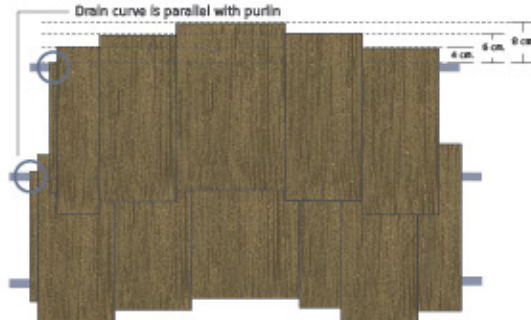
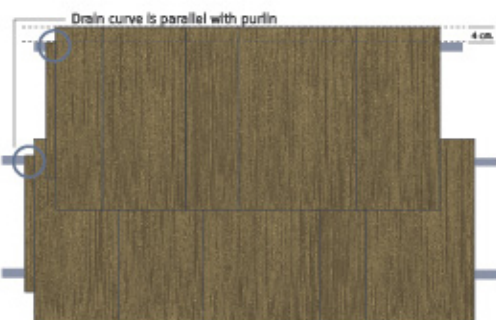

### 1. Straight Sheet

Lay **SHERA** Zedar Shake next to each other with no spacing, making sure that the drain curve is parallel with the purlin or the tile's head is 4 cm. beyond the purlin as shown in the picture. Alternate the sizes of the tile appropriately to get a straight, uniform pattern at the roof edge.

### 2. Overlapped Sheet















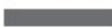



Tile sheet can be laid at 3 different levels with 2 cm. variation

- Low level: the drain curve is parallel with the purlin or the tile's head is 4 cm. beyond the purlin.
- Middle level: the tile's head is 6 cm. beyond the purlin.
- High level: the tile's head is 8 cm. beyond the purlin, as shown in the picture.

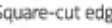









### Cautions

1. Tiles must be laid out in rows with shifting alignment at least 4 cm. from the previous row.
2. It's recommended that a box of roof tile is open and used up one at a time to reduce leftovers.
3. If roof pitch is below 25 degree, has a multi-level design or rafter length is over 10 meter, please contact the manufacturer for recommendations.







# Appendix / Ceiling Application

	Product Groups	Texture	Color	Size (cm.) (thick*width*length)	Model (Edge/Profile)	Weight Kg/pc	Quantity (pc/sq.m.)	
Skirt		Smooth	Uncolored	0.8 x 5.0 x 300	Classic	1.80	-	
				0.8 x 7.5 x 300		2.70		
	0.8 x 5.0 x 300			Modern	1.80			
	0.8 x 7.5 x 300				2.70			
Strip		Teak	Uncolored	0.8 x 5.0 x 300	Square-cut edge	1.80	6.67	
				0.8 x 7.5 x 300		2.70	4.45	
	Red Cherry		0.8 x 7.5 x 300			2.70	4.45	
		Smooth	Uncolored	0.8 x 7.5 x 300	Square-cut edge	2.70	4.45	
				0.8 x 10 x 300		3.60	3.34	
			Smooth	Red Mahogany	0.8 x 7.5 x 300		2.70	4.45
						Smooth	Uncolored	0.8 x 7.5 x 300
		0.8 x 10 x 300	3.60	3.34				
			Smooth	Red Mahogany	0.8 x 7.5 x 300		2.65	4.45
						Straight Grain	Uncolored	0.8 x 7.5 x 300
		0.8 x 10 x 300	3.55	3.33				
			Straight Grain	Modern Grey	0.8 x 7.5 x 300		2.65	4.44
							Straight Grain	Beech
		Straight Grain	Uncolored	0.8 x 5.0 x 300		Square-cut edge		
					Straight Grain	Shine Light Oak	0.8 x 7.5 x 300	
	Straight Grain	Shine Light Red Oak	0.8 x 7.5 x 300					

Shine Light  
Timeless Beauty

















	Product Groups	Texture	Color	Size (cm.) (thick*width*length)	Model (Edge/Profile)	Weight Kg/pc	Quantity (pc/sq.m.)
<b>SHERA Ceiling Board</b>		Smooth	Uncolored	0.35 x 122 x 122	Square cut edge 	8.14	0.67
				0.35 x 122 x 244		16.28	0.34
				0.40 x 122 x 122		9.30	0.67
				0.40 x 122 x 244		18.61	0.34
				0.45 x 122 x 244		20.90	0.34
				0.60 x 122 x 244		27.91	0.34
<b>SHERA Vent Ceiling Board</b>		Smooth	Uncolored	0.32 x 60 x 120	Classic	3.52	1.39
				0.40 x 60 x 120		4.41	1.39
		Smooth		0.32 x 60 x 120	Modern	3.52	1.39
				0.32 x 61 x 122		3.72	1.34
				0.40 x 60 x 120	4.41	1.39	
		Grooving Teak 3"		0.40 x 60 x 120	Embossed Teak	4.01	1.39
	Grooving Smooth 3"	0.40 x 60 x 120	3" Embossed Smooth	4.25	1.39		
<b>SHERA Deco Ceiling Board</b>		Rocco	Uncolored	0.35 x 120 x 240	-	15.77	0.35
				0.35 x 122 x 244	-	16.28	0.34
		Blossom		0.35 x 120 x 240	-	15.77	0.35
				0.35 x 122 x 244	-	16.28	0.35
		Cassia		0.35 x 120 x 240	-	15.77	0.35
					Teak	0.4 x 122 x 244	-
		Cassiano				0.45 x 122 x 244	-

# Appendix / Wall Application

	Product Groups	Texture	Color	Size (cm.) (thick*width*length)	Model (Edge/Profile)	Weight Kg/pc	Quantity (pc/sq.m.)
Plank		Antique Wood	Uncolored	0.8 x 15 x 300	Square cut edge	5.40	2.67
				0.8 x 20 x 300		7.20	2.00
		Cassia	Uncolored	0.8 x 15 x 300	Square cut edge	5.40	2.67
				0.8 x 15 x 400		7.20	2.00
		Straight Grain	Uncolored	0.8 x 20 x 300		7.20	2.00
				0.8 x 20 x 400		9.60	1.50
		Teak	Uncolored	0.8 x 15 x 300	Square cut edge 	5.40	2.67
			Modern Grey				
			Light Yellow				
			Light Blue				
			Walnut	0.8 x 15 x 400		7.20	2.00
			Merbau Brown				
			Honey Teak Brown				
			Golden Sand Teak	0.8 x 20 x 300		7.20	2.00
			Golden Teak				
			Afomosia Brown				
			Red Cherry				
			Red Mahogany				
			Shine Light Brown Teak	0.8 x 20 x 400		9.60	1.50
			Shine Light Golden Teak				
Shine Light Redwood							
Splendid Plank De'line	Smooth	Uncolored	1.0 x 22 x 300	Deline DL00	8.93	1.64	
				Deline DL01	8.77		
				Deline DL02	8.60		
				Deline DL05	8.12		
				Deline DX12	8.44		



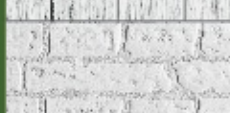
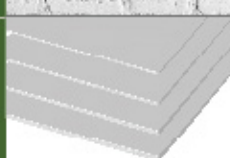













*Shine Light  
Timeless Beauty*







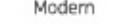
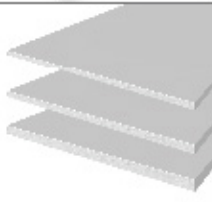





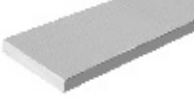

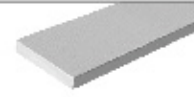
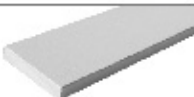



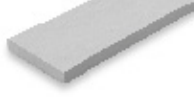

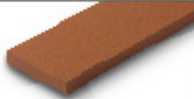
	Product Groups	Texture	Color	Size (cm.) (thick*width*length)	Model (Edge/Profile)	Weight Kg/pc	Quantity (pc/sq.m.)	
Splendid Plank		Cassia	Uncolored	1.0 x 15 x 300	Orchid Tree	6.73	2.67	
		Smooth		1.0 x 15 x 300		6.73	2.67	
		Cassia		1.0 x 20 x 300		8.97	1.67	
		Smooth		1.0 x 15 x 300	Croton	5.65	2.57	
		Cassia		1.0 x 15 x 300	Yellow Frame	5.65	2.57	
		Smooth						
		Cassia			Jacaranda	5.74	2.55	
		Smooth			Modern Stagger	1.0 x 10 x 300	3.63	4.17
						1.0 x 15 x 300	5.88	2.57
						1.0 x 20 x 300	8.13	1.86
SHERA Deco Board		Blossom	Uncolored		0.6 x 120 x 240	-	27.04	0.35
					0.6 x 122 x 244		27.91	0.34
		Rocco	Uncolored		0.6 x 120 x 240	-	27.04	0.35
				0.6 x 122 x 244	27.91		0.34	
		Cassia	Uncolored	0.6 x 120 x 240	-	27.04	0.35	
				0.6 x 122 x 244		27.91	0.34	
		Cassiano	Uncolored	0.6 x 120 x 240	-	27.04	0.35	
				0.6 x 122 x 244		27.91	0.34	
				0.8 x 120 x 240		36.05	0.35	
				0.8 x 122 x 244		37.26	0.34	
		Straight Grain 3"	Uncolored	0.6 x 120 x 240	-	27.04	0.35	
				0.6 x 122 x 244		27.91	0.34	
		Brick	Uncolored	0.6 x 120 x 240	-	27.75	0.35	
				0.6 x 122 x 244		27.91	0.34	
0.8 x 120 x 240				37.05		0.35		
SHERA Wall Board		Smooth	Uncolored	0.6 x 122 x 244	Square-cut edge	27.91		
				0.8 x 122 x 244		37.26		
				1.0 x 122 x 244		46.58		
				1.2 x 122 x 244		55.89		
		Smooth	Uncolored	0.6 x 122 x 244	Recessed edge	27.66		
				0.8 x 122 x 244		36.99		

# Appendix / Floor Application

	Product Groups	Texture	Color	Size (cm.) (thick*width*length)	Model (Edge/Profile)	Weight Kg/pc	Quantity (pc/sq.m.)
Floor Plank Color Through		Straight Grain	Wenge Brown	2.5 x 15 x 300		23.67	1.67
			Tropical Oak				
			Golden Sand Teak				
		Cassia	Chestnut Brown				
Floor Plank Color Through Anti Slip		Straight Grain	Tropical Oak	2.5 x 15 x 300		17.75	2.22
Floor Plank		Straight Grain	Jasmine White Primer	2.5 x 15 x 300		17.75	2.22
		Cassia		2.5 x 20 x 300		23.67	1.67
Floor Plank Color Through Double Series		Straight Grain	Wenge Brown	2.5 x 20 x 300		23.61	1.67
			Tropical Oak				
Floor Plank Double Series		Straight Grain	Jasmine White Primer	2.5 x 20 x 300		23.61	1.67
Floor Plank Clip-Lock Series		Straight Grain	Modern Grey	2.5 x 15 x 300		16.93	2.22
			Wenge Brown				
			Tropical Oak				
		Beech	2.5 x 20 x 300				























	Product Groups	Texture	Color	Size (cm.) (thick*width*length)	Model (Edge/Profile)	Weight Kg/pc	Quantity (pc/sq.m.)
Stair Tread		Cassia	Uncolored	2.5 x 25 x 120	Horizontal, Curved edge 	11.82	-
				2.5 x 30 x 120		14.19	-
				3.5 x 25 x 120		16.56	-
				3.5 x 27 x 120		17.89	-
				3.5 x 30 x 120		19.88	-
		Straight Grain		3.5 x 27 x 120		17.89	-
		3.5 x 30 x 120		19.88	-		
	Smooth	2.5 x 25 x 120	Horizontal, V-cut edge 	11.82	-		
Stair Tread Anti Slip		Straight Grain	Tropical Oak	2.5 x 25 x 120	Horizontal, Curved edge 	11.82	-
			Wenge Brown				
		Tropical Oak	1.6 x 20 x 120	Vertical, Square-cut edge 	5.97	-	
		Wenge Brown					
Skirt		Smooth	Uncolored	1.2 x 10 x 300	Classic 	5.33	-
					Modern 		-
Skirt Ending		Smooth	Uncolored	1.2 x 10 x 100	Classic 	1.83	-
					Modern 		
SHERA Floor Board		Smooth	Uncolored	1.5 x 122 x 244	Square-cut edge 	69.32	0.35
				1.8 x 122 x 244		83.19	
				2.0 x 122 x 244		92.43	

# Appendix / Decorative Application

	Product Groups	Texture	Color	Size (cm.) (thick*width*length)	Model (Edge/Profile)	Weight Kg/pc	Quantity (pc/sq.m.)
D�cor Wood		Cassia	Uncolored	1.6 x 7.5 x 300	Square-cut edge 	5.60	4.44
				2.5 x 5.0 x 300		5.92	6.67
				2.5 x 10 x 300		11.83	3.33
		Smooth	Uncolored	1.6 x 5.0 x 300		3.74	6.67
				1.6 x 7.5 x 300		5.60	4.44
		Straight Grain	Uncolored	2.5 x 5.0 x 300		5.92	6.67
Fence		Smooth	Uncolored	1.2 x 10 x 300	Modern 	5.33	
			Coral White	1.6 x 10 x 150		3.74	
			Honey Teak				
			Coral White	1.6 x 10 x 100		2.46	
			Honey Teak	1.6 x 10 x 150		3.71	
			Straight Grain	Oak Shine Light		1.6 x 10 x 100	
		Red Oak Shine Light					
		Red Berry Shine Light					
		Oak Shine Light					
				1.2 x 10 x 300	Modern 	5.34	
		Red Oak Shine Light					

*Shine Right  
Timeless Beauty*

# Appendix / Roof Application

	Product Groups	Texture	Color	Size (cm.) (thick*width*length)	Model (Edge/Profile)	Weight Kg/pc	Quantity (pc/sq.m.)	
Zedar Shake		-	Yellow Zante	1.2 x 10 x 35	Zedar Shake	0.75	-	
			Brown Chestnut	1.2 x 15 x 35		1.19	-	
			Black Wenge	1.2 x 20 x 35		1.47	-	
			Metro Grey	1.2 x 20 x 35		1.47	-	
Eaves Pro		Smooth	Uncolored	1.6 x 15 x 300	Curved edge 	10.99	-	
			Coral White	1.6 x 20 x 300		14.73	-	
			Honey Teak Brown	1.6 x 15 x 400		13.56	-	
			Red Mahogany	1.6 x 20 x 400		19.64	-	
		Smooth	Uncolored	1.6 x 15 x 300	Beveled edge 	11.03	-	
			Coral White	1.6 x 20 x 300		14.77	-	
			Honey Teak Brown	1.6 x 15 x 400		14.71	-	
			Red Mahogany	1.6 x 20 x 400		19.69	-	
		Smooth	Coral White	1.6 x 24 x 300	Eaves Pro 	17.05	-	
			Honey Teak Brown	1.6 x 24 x 400		22.73	-	
	Eaves One Plus		Smooth	Uncolored	1.6 x 23.5 x 300 1.6 x 23.5 x 400 2.2 x 23.5 x 300 2.2 x 23.5 x 400	Eaves One Plus 	15.29 20.39 21.33 28.45	-
				Red Mahogany	2.2 x 23.5 x 300 2.2 x 23.5 x 400		21.33 28.45	-
Senepa <small>(Available in Philippines only)</small>		Smooth	Uncolored	1.2 x 25 x 244 1.2 x 30 x 244	Senepa 	10.31 13.90	-	



---

---

---

---

---

---

---

---

---

---

---

---

---

---

---

---

---

---

---

---

---

---

---

---

---

---

---

---

---

---







**SHERA Public Company Limited (Head Office)**  
2426/3 Mahaphant Building, Chareonkrung Road,  
Bangkorlhaem, Bangkok 10120, Thailand

**SHERA Myanmar CO.,LTD**  
LOT. NO.FG-2, Nway Oo Kant Kaw Street,  
Fontana Gardens FMI City,  
Hlaing Tharyar Township, Yangon, Myanmar

**SHERA Vietnam CO.,LTD**  
Room 8.6, 8th Floor, Le MeridienBuilding,  
3C Ton Duc Thang Street, Ben Nghe Ward,  
Dist1, Ho Chi Minh City, Vietnam

**SHERA Building Solutions India Private Limited**  
WeWork Raheja Platinum, Sag Baug,  
Off Andheri-Kurla Road, Marol, Andheri (East),  
Mumbai – 400 049, Maharashtra, India.

**SHERA Building Solution Indonesia**  
Gedung The City Tower Lantai 12 Suite 1-N,  
Jl. MH. Thamrin No. 81, Kelurahan Menteng,  
Kecamatan Menteng, Jakarta Pusat

**SHERA Building Solution (Philippines) Corp.**  
Level 20-1, One Global Place,  
5th Avenue & 25th Street, Bonifacio Global City,  
Taguig 1632 Philippines

**SHERA call Center : +662 289 9888 F : +66 2 289 9800**  
**E-mail : callcenter@shera.com**

Colors of products shown in pictures may differ from the actual products due to printing system.  
We reserve the right to modify any of the information in this document without prior notice.  
Version : 2021

[www.SHERA.com](http://www.SHERA.com)



Website : [SHERA](http://SHERA)